

# Z-BEAST

FINISH MOWER by **DEK**

## Owner's Manual

This manual contains important safety instructions for the gasoline engine powered lawnmower models: 54ZB, 62ZB

READ SAFETY WARNINGS AND OPERATING INSTRUCTIONS CAREFULLY.  
SAVE THIS MANUAL.



### Need Help?

Parts, Service  
and Technical Assistance call:

1-919-550-3221

1-800-393-0668

[www.gxioutdoorpower.com](http://www.gxioutdoorpower.com)

When you call the help-line you will need to have the following information:

Date of Purchase: \_\_\_\_\_  
Location of Purchase: \_\_\_\_\_  
Serial # - Chassis: \_\_\_\_\_  
Serial # - Engine: \_\_\_\_\_  
Serial # - Hydro Trans (L) \_\_\_\_\_  
Serial # - Hydro Trans (R) \_\_\_\_\_

Mower and engine life are extended greatly by performing frequent lubrications, oil changes and regular maintenance. To protect your investment perform routine maintenance.

See Page 2 for Serial # Locations

Copyright© 2010 by GXi Outdoor Power, LLC. All rights reserved.

No part of this publication can be reproduced or distributed without prior written permission of GXi Outdoor Power, LLC Clayton, NC 27520 USA.

DEK is a registered trademark of GXi Outdoor Power, LLC

GXi Outdoor Power, LLC reserves the right to discontinue or change specifications or design at any time without notice and without incurring any obligation whatsoever.

The information and specifications included in this publication were in effect at the time of approval for printing.

**WARNING**

The engine exhaust from this product contains chemicals known to the state of California to cause cancer, birth defects, or other reproductive harm.

**NOTICE OF REQUIREMENT OF SPARK ARRESTER MUFFLER**

This equipment may create sparks that can start fires around dry vegetation. California Public Resources Code Section 4442.6 provides that it is unlawful to use or operate an internal combustion engine on any forest-covered, brush-covered, or grass-covered land unless the engine is equipped with a spark arrester maintained in effective working order. A spark arrester is a device constructed of nonflammable materials specifically for the purpose of removing and retaining carbon and other flammable particles over 0.0232 of an inch in size from the exhaust flow of an internal combustion engine that uses hydrocarbon fuels or which is qualified and rated by the United States Forest Service. Other states or federal areas may have similar laws. The operator should contact local fire agencies for laws or regulations relating to fire prevention requirements. **CONTACT THE ENGINE MANUFACTURER IF YOUR AREA REQUIRES A SPARK ARRESTER.**



**This manual contains important safety instructions for Finish Mowers  
READ SAFETY WARNINGS AND OPERATING INSTRUCTIONS CAREFULLY  
SAVE THESE INSTRUCTIONS.**

**This owner's manual is considered a permanent part of the finish mower and should remain with the finish mower if resold. Should the owner's manual become damaged or illegible, replace immediately.**

# BEAST SERIES

Check out our other great products at [www.HomeDepot.com](http://www.HomeDepot.com)  
or visit our website at [www.beastpowerequipment.com](http://www.beastpowerequipment.com)

## **TURF BEAST**

36-inch & 54-inch Walk  
Behind Mower



## **Z-BEAST**

54-inch & 62-inch Zero-Turn  
Mower



## **SNOW BEAST**

36-inch & 45-inch Snow  
Blower



## **BRUSH BEAST**

36-inch Brush Mower



## **BRUSH MASTER**

Chipper/Shredder  
with 2-Way Feed



## **THE BEAST**

100-inch Tow Behind Mower



Safety Information and Warnings.....	1
Inspection and Serial Number Locations .....	2
Preparation Safety Precautions .....	3
Operation Safety Precautions .....	4,5
Roll Over Protective Structure (ROPS).....	6
Slope Diagram.....	7
Safety Decals .....	8
Product Specifications .....	9
Control Panel and Lawn Mower Components .....	10
Missing Parts Request Form.....	11
Operating Instructions .....	12
Starting the Engine.....	12
Operating the Mower .....	13
Changing the Cut Height .....	14
Disengaging Hydraulic Drive Units.....	15
General Maintenance .....	16
Maintenance Schedule .....	17
Service Adjustments.....	18
Return to Neutral.....	18
Deck Belt Adjustment.....	19-22
Spindle Break Inspection and Replacement .....	23
Removing the Blades.....	23
Engine-to-Hydraulic Drives Belt Adjustment.....	24
Hydraulic Drive System Adjustment.....	25
Safety System Adjustment.....	26
Tracking Adjustment.....	26
Lubrication.....	27
Battery.....	27
Storage Instructions .....	28
Troubleshooting .....	29,30
Limited Warranty and Service.....	31
Quick Start Guide.....	32-34

### **About the BEAST Mower Manual**

Congratulations on the purchase of your new BEAST commercial mower. We at GXi Outdoor Power are confident that this mower will provide excellent performance, outstanding quality, and great durability when operated and maintained as directed in this manual.

1. This manual contains assembly, operating, safety, adjustment, maintenance, and troubleshooting instructions. BEFORE OPERATING YOUR LAWN MOWER, CAREFULLY READ THIS MANUAL IN ITS ENTIRETY.
2. This owner's manual is considered a permanent part of the mower. It must be available to all operators and/or persons servicing the mower. Should the mower be resold, this manual must remain with the mower.
3. All information, illustrations, and specifications contained in this manual were in effect at the time of the publication. GXi Outdoor Power reserves the right to add, delete or modify specifications and/or designs without notice.
4. If you ever have questions in regards to the operation, maintenance or safety of your mower, please contact the GXi Parts & Service, LLC at 1-919-550-3221 or 1-800-393-0668.

**Safety Information**

BEAST lawn mowers are designed to provide safe and dependable service if operated according to instructions. Read and understand this owner's manual before operating your lawn mower.

**Emission Control System Information**The U.S. and California Clean Air Acts

EPA and California regulations require all manufacturers to furnish written instructions describing the operation and maintenance of emission control systems. The following instructions and procedures must be followed in order to keep the emissions from your engine within the emission standards.

**Safety Label Locations**

Safety labels are located on your mower to warn you of potential hazards. Read them carefully. If a label comes off or becomes hard to read, contact GXi Parts and Service, LLC for a replacement.

**Operator Responsibility**

It is the owner's responsibility to insure that all operators and mechanics are trained and have read this manual before operating the mower as well as being physically able individuals. They should be instructed about safe operation and mechanical procedures. If they can not read or understand English, it is the owner's responsibility to explain all safe operating instructions. The owner or operator is responsible for accidents or injuries occurring to themselves, other people, or property. Potential misfortunate incidents can be prevented by the owner/user.

**Training**

1. Read, understand, and follow all instructions on the machine and manual(s) before attempting to assemble and operate.
2. Operator must be familiar with all controls, their operations, and how to stop the engine and disengage the controls quickly.
3. Never allow children to operate this machine.
4. Never allow adults to operate this machine without proper instruction.
5. Keep bystanders, helpers, pets and children at a safe distance from the machine while it is in operation.
6. Keep area of operation clear of objects that can be thrown by the machine.
7. Wear eye and ear protection while operating the machine.

**Children**

1. Never allow children to operate or ride on the machine.
2. Always keep children at a safe distance when operating or servicing the machine.
3. Make sure to always look out for children before you make turns or reverse.
4. Never let children or untrained people operate or service the machine. Local regulations may restrict the age of the operator



Wear appropriate clothing including hard hat, safety glasses and hearing protection. Long hair, loose clothing or jewelry may get tangled in moving parts.



Do not operate the mower with defective guards, shields, or without the safety devices securely in place.



**WARNING!** Do not use your BEAST lawn mower to carry passengers. Keep bystanders, helpers, pets and children at a safe distance from the machine while it is in operation. Inspect the area where the equipment is to be used and remove all objects such as rocks, toys, and wires which can be thrown by the machine causing serious injury or death.

**Mower Inspection**

For your safety, inspect the lawn mower before each use. Before you begin your inspection, be sure the following conditions are met: the lawn mower should be on a level surface, with the ignition switch off, the key removed, the brake set, and the blades disengaged. Also, disconnect the spark plug wires from the spark plugs and ground them against the engine to prevent inadvertent starting.

1. Walk around the mower and look for any fluid spills or leaks on or underneath the mower. Remove any and all excessive debris, dirt, and fluids.
2. Look for signs of damage or excessive wear. Check the tightness of all nuts, bolts, pins, and screws. Tighten any that may be loose and replace any that are missing.
3. Be sure the safety switches are operating properly so that the engine cannot be started unless the blades are disengaged.
4. Check the mower blades for any damage or abnormal wear. If replacement is required, replace in sets so that they are balanced.
5. Check the tire pressure of all four tires. Do not exceed the maximum pressure indicated on the tire.
6. Check the belts for damage or wear.
7. Check engine oil and air filters as recommended in the engine manufacturer's manual.

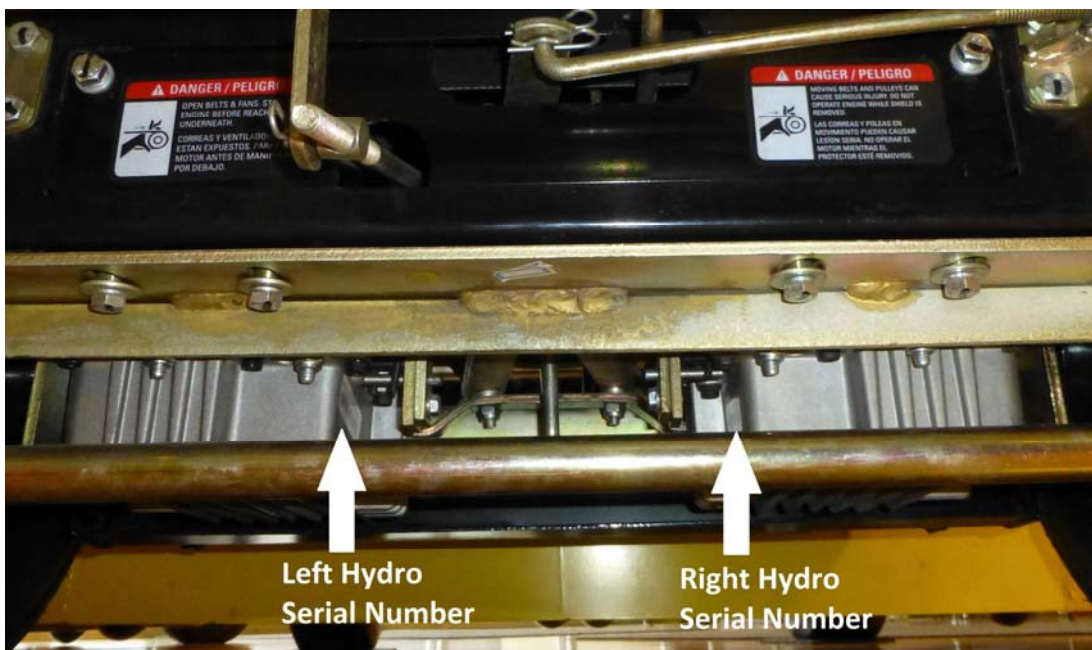
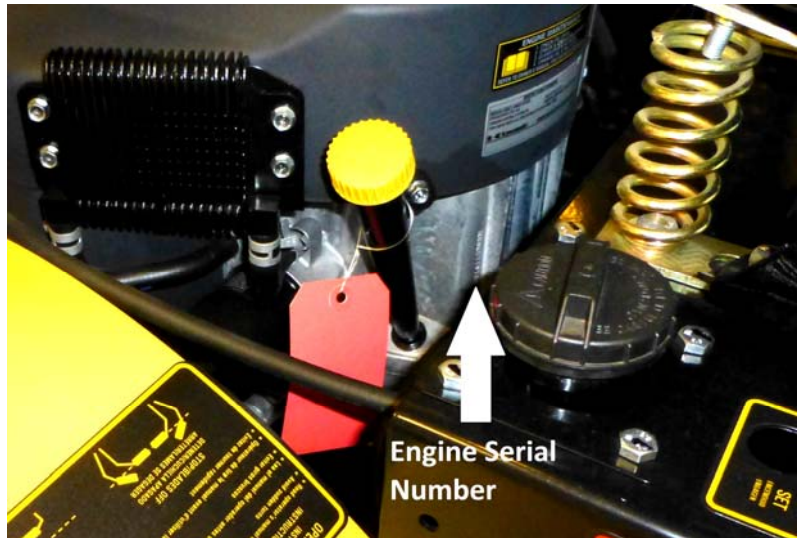

**Preparation—Safety Precautions**

1. Evaluate the terrain to determine what accessories and attachments are needed to properly and safely perform the job. Only use accessories and attachments approved by BEAST.
2. Inspect the area where the equipment is to be used and remove all objects such as rocks, toys, and trash which can be thrown by the machine causing serious injury or death.
3. People, pets, and children must not be near the area being mowed. Do not operate the mower in their presence.
4. Never operate mower with damaged guards, shields or covers.
5. All users of the mower must be alert and pay attention to safety alerts, symbols, and safety signs.
6. Be sure to inspect mower before each use.
7. Always use roll bar when possible and never remove or modify the roll bar in any way or form.
8. Check the controls and shields to make sure that they are functioning properly before operating. Do not operate if any are damaged or missing.
9. Never operate with discharge deflector raised, removed, or altered, unless a grass catcher is being used.
10. Install, and maintain in working order, a spark arrester before using equipment on forest-covered, grass-covered, or brush-covered unimproved land.

**Gasoline and other fuels—Safety Precautions**

Use extra care when handling gasoline and other fuels as they are flammable and vapors can explode.

1. Only use gasoline approved containers for storage and keep out of reach of children.
2. Do not fill fuel tank completely full. Overfilling may result in fuel leakage. Leave a reasonable amount of space for fuel to expand.
3. If fuel is spilled, do not start the engine. Move the mower away from the area, wipe up the spill thoroughly and wait until fuel vapors have evaporated before starting engine.
4. Do not fill gasoline containers inside a vehicle or on a truck/trailer bed.
5. Never remove fuel cap or add fuel when engine is running.
6. Avoid prolonged breathing of gasoline vapors.
7. Never refuel or drain the machine indoors.
8. Keep face away from nozzle and gas tank opening.
9. Keep gas and other fuels away from skin and eyes.
10. Never use the mouth to siphon gas.
11. Never refuel the mower until all moving parts on the mower have stopped.
12. Never smoke when handling fuels and stay away from an open flame where fumes can be ignited by a spark.
13. Always place gasoline containers on the ground away from your vehicles prior to filling.
14. Gasoline is harmful or fatal if swallowed.



**DANGER: GASOLINE IS HIGHLY FLAMMABLE AND EXPLOSIVE.** Do not add fuel while the engine is running or is hot. Keep open flames, sparks, and heat away from the fuel and store fuel in containers specifically designed for that purpose. **ADD FUEL OUTDOORS ONLY. IF THE FUEL IS SPILLED, DO NOT START THE ENGINE.** Manually push the mower away from the spill and wipe up immediately.

**Equipment Operation—Safety Precautions**

1. Do not operate the engine in a confined space where dangerous carbon monoxide fumes can collect. Carbon monoxide is odorless, tasteless, and can be fatal.
2. Mow only in daylight or under good lighting conditions.
3. Make sure the mower is in neutral, parking brake is engaged, blades are disengaged, seat belt on, roll bar is raised and the operator is sitting in the proper position before attempting to start the engine.
4. Never operate on wet grass.
5. Watch for pedestrian or vehicular traffic when moving the mower while not in use (e.g., loading, unloading, or transporting).
6. Never operate the mower with defective guards or shields, or without the safety devices securely mounted in place and functioning properly.
7. Be aware of discharge and never direct discharge of material toward bystanders or allow anyone, especially children, near the mower during operation.
8. Do not change the governor settings or over speed the engine.
9. Always stop the engine when you leave the mower, even for a moment.
10. To help reduce fire hazard, keep the engine and the area around the engine free of grass, leaves or any other type of foreign material.
11. Beware of cutting edges. For safety always wear gloves when performing blade maintenance activities. Beware on multiple blade units since the rotation of one blade may cause the rotation of another blade.
12. Do not operate the mower with the grass chute deflector in the raised position. Serious injury could occur.
13. If lightning is seen or thunder is heard, do not operate machine. Instead find shelter, as lightning may cause injury/death.
14. Never raise the mower deck while the blades are running.
15. Stop on a level ground, disengage drive, engage parking brake, and shut off engine before leaving operator's position for any reason including clearing grass catcher or unclogging the chute.
16. Stop the mower immediately and inspect blades after striking objects or if an abnormal vibration occurs. Discontinue use until repaired.
17. Keep hands and feet away from cutting deck. This product is capable of amputating hands and feet and throwing objects.
18. Be alert and slow down when making turns. Also look left, right, and behind before changing directions and reversing to be sure there is a clear path.
19. Disengage blades, slow down, and drive cautiously when crossing roads and side walks.
20. Never operate mower under the influence of alcohol or drugs.
21. Use care when loading or unloading the machine into a trailer or truck.
22. Use care when approaching blind corners, shrubs, trees, or other objects that may obstruct vision.
23. Always disengage blades when not cutting grass.
24. Never listen to music with headphones/earphones while operating the mower.

**WARNING!**

**DO NOT OPERATE ON SLOPES EXCEEDING 15 DEGREES! OPERATING ON SLOPES EXCEEDING 15 DEGREES INCREASES THE RISK OF A ROLLOVER RESULTING IN SERIOUS INJURY.**

**OPERATING ON SLOPES EXCEEDING 15 DEGREES ALSO CAUSES PREMATURE WEAR ON HYDRAULIC DRIVES.**

**ALWAYS MOW ACROSS SLOPES. DO NOT MOW UP AND DOWN.**



**Slope Operation—Safety Precautions**

1. Do not mow on slopes greater than 15 degrees.
2. Be extremely careful when operating the mower on a slope. Reduced traction could cause sliding.
3. Do not stop or start suddenly when going uphill.
4. Slow down and use caution when making turns and when changing direction on slopes.
5. Do not operate a riding mower near steep slopes, ditches, or water. Use a walk behind mower or a hand trimmer for these areas.
6. Roll bar should be raised and locked with seat belt buckled before engine is turned on.
7. Should it be necessary to lower the roll bar, the seat belt should not be used.
8. If tires lose traction, disengage the blades and drive slowly and cautiously off the slope.
9. Use extreme care with attachments as they can change the stability of the mower and cause loss of control.
10. Slow down and drive extra carefully on hillsides. Be sure to drive in the recommended direction on hillsides. Turf conditions can affect the machine's stability.
11. The parking brake may not hold the mower if parked on a slope.

**IMPORTANT!** The mower belts are adjusted to ensure the blades stop turning within seven (7) seconds of releasing the blade control lever. If you are making any belt adjustments whatsoever, for your safety and the safety of others around you, you must ensure the belts are re-adjusted to achieve this design specification.

**DANGER:** Do not bypass, modify, alter or disconnect the safety system. Make sure that the safety interlock system is fully operational each time before mowing.

Before attempting to use your mower, make sure you are familiar with all of the components and have read the manual.

**GASOLINE IS HIGHLY FLAMMABLE AND EXPLOSIVE. FUEL LEAKS, A LOOSE FUEL TANK, OR A LOOSE FUEL VALVE CAN LEAD TO SEVERE INJURY OR DEATH. DO NOT OPERATE THIS MOWER IF ANY COMPONENT OF THE FUEL SYSTEM IS LOOSE OR LEAKS GASOLINE!**

Before setting up your BEAST mower, disconnect the spark plug wires from the spark plugs and ground them against the engine to prevent inadvertent starting. This step should be taken as a precaution whenever you are working on this machine.

**Need Help?**

Parts, Service  
and Technical Assistance call:

**1-919-550-3221**

**800-393-0668**

[www.gxioutdoorpower.com](http://www.gxioutdoorpower.com)

**Roll Over Protective Structure (ROPS)**

This mower is equipped with a roll over protective structure (ROPS) and a seat belt. Do not remove the ROPS or seat belt. ROPS reduces the chance of injury in the event of a rollover. Overturning the machine without ROPS can result in serious injury or death. **ALWAYS** use the seat belt when the ROPS is in the raised position.

If the ROPS must be lowered for clearance, return ROPS to raised position when clearance is no longer required. **NEVER** use the seat belt when the ROPS is in the lowered position. If the ROPS is lowered for transportation, return it to the raised position before operating the machine.

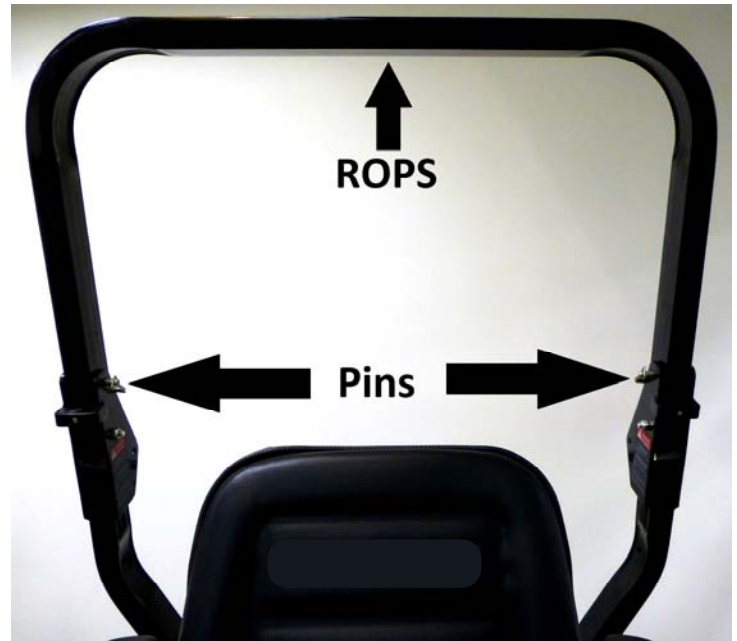

**WARNING**

**ALWAYS** use the seat belt when the ROPS is in the raised position. Failure to do so could result in serious injury or death in the event of a rollover. **NEVER** use the seat belt with the ROPS in the lowered position.

**Lowering ROPS**

If additional clearance is needed the ROPS may be lowered. Lower the ROPS using the following steps:

1. Remove the two retaining pins.
2. Place the ROPS in the lowered position.
3. Insert the pins into the lowered position holes.

**NEVER** use the seatbelt when the ROPS is in the lowered position. Return ROPS to the raised position when additional clearance is no longer required.



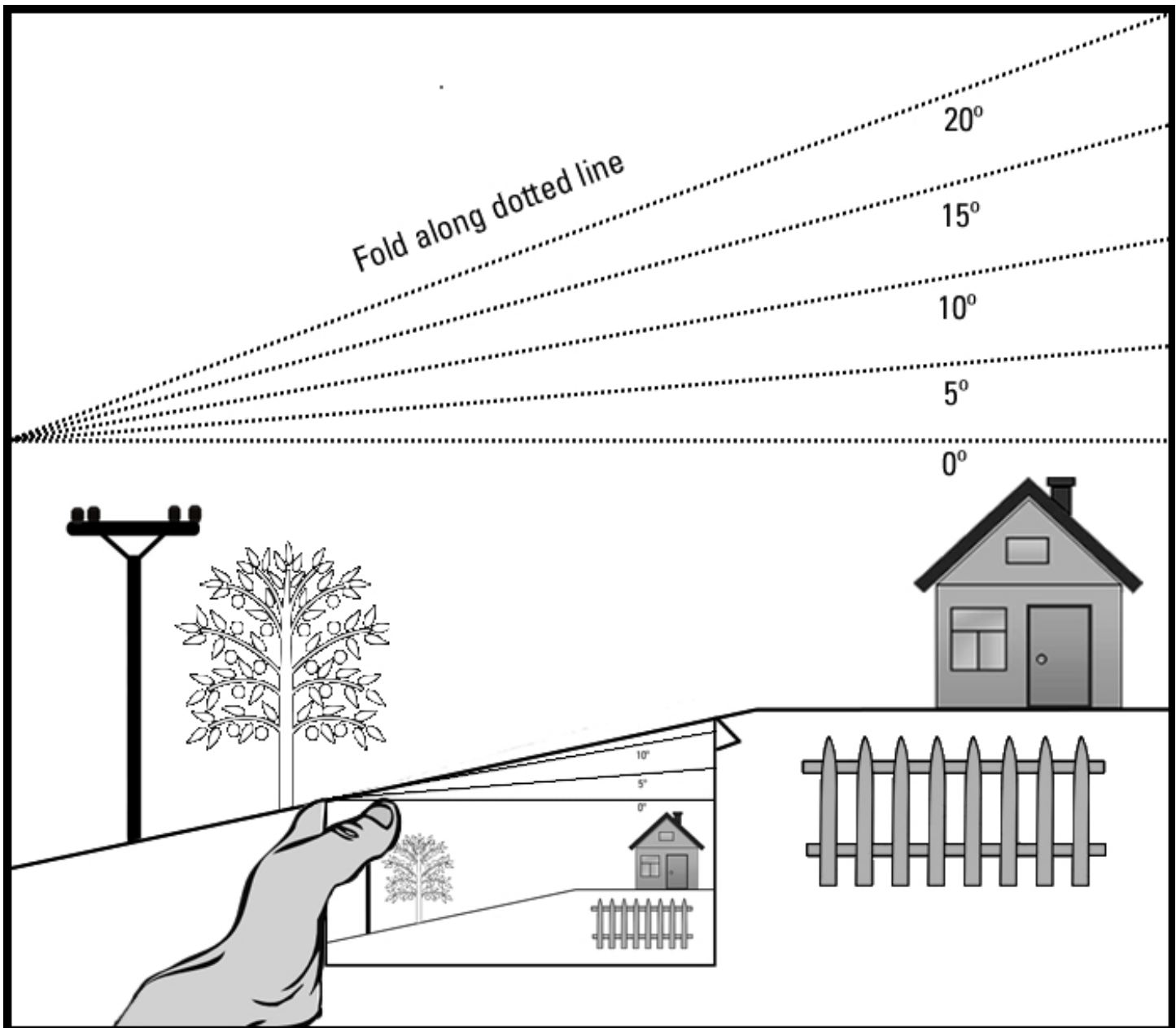

The maximum slope angle you can safely operate your mower on is **15 degrees**. Do not exceed 15 degrees with your mower.

1. Line up the side of this page with a vertical object to gauge the angle of the slope.
2. Fold this sheet along the dotted line and verify the slope is not in excess of 15 degrees.

### **WARNING!**

**DO NOT OPERATE ON SLOPES EXCEEDING 15 DEGREES! OPERATING ON SLOPES EXCEEDING 15 DEGREES INCREASES THE RISK OF A ROLLOVER RESULTING IN SERIOUS INJURY.**

**OPERATING ON SLOPES EXCEEDING 15 DEGREES ALSO CAUSES PREMATURE WEAR ON HYDRAULIC DRIVES.**

**ALWAYS MOW ACROSS SLOPES. DO NOT MOW UP AND DOWN.**

**Safety Decal Identification**

The labels shown below are located on your mower to warn you of potential hazards and provide you with important safety information. If these decals become difficult to read or are missing from the mower, please contact GXi Parts & Service, LLC at 1-919-550-3221 or 800-393-0668 or [www.gxioutdoorpower.com](http://www.gxioutdoorpower.com) for a replacement.

**⚠ DANGER / PELIGRO**

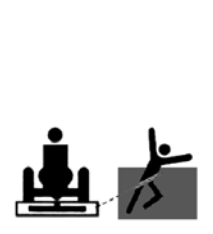

OBJECTS HIDDEN IN THE LAWN CAN BE THROWN BY THE MOWER BLADE. THROWN OBJECTS CAN CAUSE SERIOUS INJURY.

- CLEAR LAWN OF ALL DEBRIS BEFORE MOWING
- DO NOT OPERATE THE MOWER WITHOUT EITHER THE DISCHARGE GUARD OR THE ENTIRE GRASS CATCHER IN PLACE
- WEAR EYE PROTECTION
- KEEP PEOPLE AND PETS AWAY

OBJETOS OCULTOS EN EL CÉSPED PUEDEN SER LANZADOS POR LA CUCHILLA. LOS OBJETOS LANZADOS PUEDEN CAUSAR LESIÓN SERIA.

- QUITAR EXCOMBROS DEL CÉSPED ANTES DE PODARLO
- NO OPERAR LA PODADORA SIN QUE ESTEN EL PROTECTOR DE DESCARGA Y EL COLECTOR DE CÉSPED EN EL LUGAR APROPIADO
- USAR PROTECCIÓN PARA LOS OJOS
- MANTENER PERSONAS Y MASCOTAS ALEJADAS

**⚠ DANGER / PELIGRO**

**KEEP HANDS AND FEET AWAY!**  
MANTENER MANOS Y PIES ALEJADOS



**⚠ DANGER / PELIGRO**



OPEN BELTS & FANS. STOP ENGINE BEFORE REACHING UNDERNEATH.

CORREAS Y VENTILADORES ESTAN EXPUESTOS. PARAR EL MOTOR ANTES DE MANIPULAR POR DEBAJO.

**⚠ DANGER / PELIGRO**



MOVING BELTS AND PULLEYS CAN CAUSE SERIOUS INJURY. DO NOT OPERATE ENGINE WHILE SHIELD IS REMOVED.

LAS CORREAS Y POLEAS EN MOVIMIENTO PUEDEN CAUSAR LESIÓN SERIA. NO OPERAR EL MOTOR MIENTRAS EL PROTECTOR ESTÉ REMOVIDO.

**⚠ DANGER / PELIGRO**

When adjusting or changing belts, clutch must be adjusted so blades stop within 7 seconds. If blades will not stop, inspect and replace damaged brakes.

Cuándo se ajusten o cambien las correas, el embargue debe ser ajustado para que las cuchillas se paren en 7 segundos, si las cuchillas no se paran, inspeccionar y reemplazar el freno dañado.

**⚠ DANGER PELIGRO**



- Do NOT mow when children or others are around.
- NEVER carry children even with the blades off.
- NO corte el césped cuando los niños u otras personas presentes.
- NUNCA lleve los niños, incluso con hojas de fuera.
- NE tondez pas quand les enfants ou les autres sont autour.
- NE transportez jamais d'enfants, meme avec des lames au large

**⚠ DANGER PELIGRO**

**AVOID INJURY OR DEATH FROM ROLLOVERS**

Keep roll bar locked in the raised position and use seat belt.

**NO ROLLOVER PROTECTION WHEN ROLL BAR IS DOWN**

Lower the roll bar only if necessary. Do NOT wear the seat belt with the roll bar lowered.

Raise the roll bar when clearance allows. Always use safe driving practices and do not operate on slopes greater than 15°.

Read the owner's manual and follow all slope operation instructions and warnings.

Feature	Models	
	54ZB	62ZB
Product Type	Commercial, 0-turn	Commercial, 0-turn
Cutting Width	54-inch	62-inch
Engine	See engine manufacturer's manual	See engine manufacturer's manual
Engine Start	Electric	Electric
Transmission Type	Dual hydraulic	Dual hydraulic
Transmission Mfg.	GXi	GXi
Mower Speeds	Infinitely variable	Infinitely variable
Deck Type	Floating, quick change	Floating, quick change
Cutting Height	1.5– 5 inches( ½-inch increments)	1.5– 5 inches( ½-inch increments)
Blade Engagement	Manual clutch	Manual clutch
Blade Tip Speed	18,750 ft/min	18,750 ft/min
Anti-Scalping Rollers	4 front/2 rear	4 front/2 rear
No. Blades/ Length	3, 18.5-inch blades	3, 21-inch blades
Control System	Dual Control Lever	Dual Control Lever
Fuel/Capacity	Gasoline/7.5 gals.	Gasoline/7.5 gals.
Rear Drive Tires	22-inch X 10-inch turf tread	22-inch X 10-inch turf tread
Front Caster Tires	15-inch X 6-inch smooth tread	15-inch X 6-inch smooth tread
Brake System	Internal hydraulic and mechanical park	Internal hydraulic and mechanical park
Weight	1,200 lbs.	1,200 lbs.
Height/Length	72 inches x 83 inches	72 inches x 83 inches

**Transmission Specifications**

**Hydraulic drives:**

Pump Displacement—12.1 cc/rev  
 Motor Displacement—14.6 cc/rev

**Overall drive system:**

Output torque—Up to 350 lb-ft  
 Speed—Up to 10 MPH  
 Axle diameter—1.2 in. (30 mm)



Note: product specifications may change without notice.

Throughout this manual, instructions are given on the operation of your BEAST mower. We recommend that while going through this manual, you have your mower available for quick and easy access in order to orient yourself with the controls, maintenance and orientation of different parts. Please read through the manual before operating.

**Control Panel**

Below, you will find a diagram of the control panel. Please take the time to familiarize yourself with the mower controls.

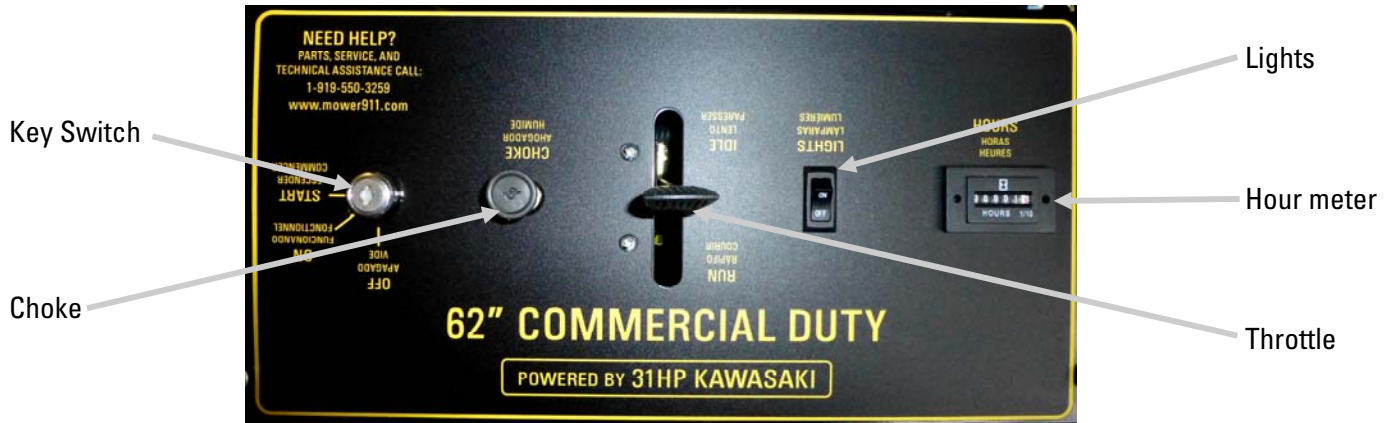

**Lawn Mower Component Identification**

(Some components may appear different than shown, depending on the model.)



Please indicate the part that you are missing:\*

Other

\_\_\_\_\_  
\_\_\_\_\_  
\_\_\_\_\_

Date of purchase \_\_\_\_\_

Model #: \_\_\_\_\_

Serial #: \_\_\_\_\_

\_\_\_\_\_  
Name

\_\_\_\_\_  
Address

\_\_\_\_\_  
Phone

\_\_\_\_\_  
Email

Comments:

**IMPORTANT!**

**Please include your receipt. Without a receipt, your order will be delayed.  
You may also email us at:**

**customerservice@gxioutdoorpower.com**

**Fax: 1-919-550-3277**

**Tel: 1-800-393-0668**

**If emailing, please scan your proof of purchase and attach to email.**

### Starting the Engine



Before attempting to use your mower, make sure you are familiar with all of the components and have read the manual.

**DANGER:** Exhaust contains poisonous carbon monoxide, a colorless and odorless gas. Breathing exhaust can cause loss of consciousness and may lead to death. Do not operate the engine in a confined space where dangerous carbon monoxide fumes can collect.

**NOTE:** Be sure to add fresh unleaded gasoline and fill the engine to the proper level with manufacturers recommended motor oil before starting your mower.



1. Make sure the shut off valve, located at the bottom of the tank, is in the ON position.

2. Make sure the brake is set and the 2 control handles are spread open into their neutral position.



3. Make sure the blade control lever is in the OFF position.

4. Pull CHOKE and set the throttle to the RUN position.

5. Turn the key clockwise to the START position and allow it to return to the ON position when the engine starts.

6. When the engine starts to run and the key returns to the ON position, push CHOKE off.





### Operating the Mower

1. Make sure the brake has been moved to the OFF Position.
2. Pull both control handles to the center.
3. To drive the mower forward, push both handle bars forward away from the chest. The forward speed is directly proportional to the degree these handles are moved forward.
4. To turn the mower left, push the right handle further forward than the left handle.
5. To turn the mower right, push the left handle further forward than the right handle.
6. To stop the forward motion of the mower, move both the handles to the center/neutral position.
7. To drive the mower backwards, pull both handles backwards toward the chest.
8. To turn to the left in reverse, pull the right handle further back than the left handle.
9. To turn right in reverse, pull the left handle further back than the right handle.
10. To zero turn to the right, push the left handle forwards and the right handle backwards.
11. To zero turn to the left, push the right handle forwards and the left handle backwards.
12. When in the neutral position, the hydraulic system prevents the mower from moving easily. However, on a grade, the mower can move very slowly (with the engine off or running). Be sure to set the manual parking brake any time the mower is left unattended or is being transported.
13. When the handles are in the middle position they can be pushed away from each other to lock the mower in the neutral .

**\*Note: the hydraulic drive units are shipped with summer oil. At cooler temperatures the hydraulic drive units may require 5 to 10 minutes of warm up for optimum performance. This warm up may be longer in cool weather and shorter in warm weather.**

**OPERATION INSTRUCTIONS**  
 INSTRUCCIONES DE SERVICIO  
 INSTRUCTIONS DE FONCTIONNEMENT

- Read operator's manual before using mower
- Avoid sudden turns
- Lea el manual del operador antes de usar la podadora
- Evitar giros bruscos
- Opérateur de lire le manuel avant d'utiliser la tondeuse
- Évitez de tourner rapidement

**STOP/BLADES OFF**  
 DETENER/CUCHILLA APAGADO  
 ARRÊTER/LAMES SE DÉGAGER



**FWD**

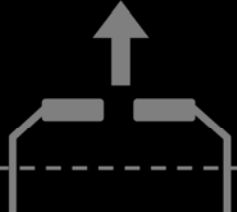

**REV**

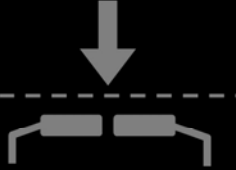

**LEFT**



**RIGHT**

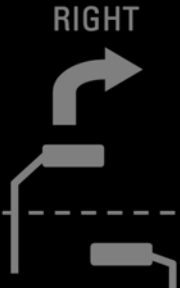

### Changing Cut Height

Your mower is equipped with an easily adjustable floating deck, which can be adjusted for cut heights of 1½ inches to 5 inches in ½-inch increments. The deck height adjuster is located on the right side of the mower.

### How to Change the Cut Height

1. Disengage blades.
2. Extend the deck height handle by pulling it up.
3. Pull the deck height handle toward the seat and pivot back or forward to shift the deck up or down to the desired height.
4. Push the deck height handle away from the seat to lock it in the desired position.
5. After deck height is changed the lever should be pushed back down to its original position.

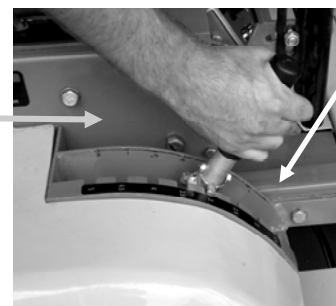
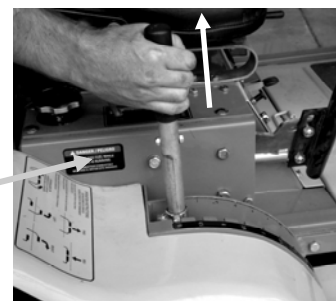

**Note:** After mowing, remember to raise the deck to its highest position to avoid scraping or any other kind of damage to the blades or deck.

### Mowing



Thoroughly inspect the area where you plan to use the mower. Look for items such as stones, sticks, wire, and other foreign objects. If struck by the mower, these and other objects may become projectiles that could lead to serious



Do not operate the mower with defective guards, shields, or without the safety devices securely in place.

**This mower is equipped with a Soft Start feature. The Soft Start feature gradually engages the blades to increase belt, clutch, and engine life. NEVER "slam" the blade on/off handle from off to on without pausing an adequate time in the Soft Start range. Doing so will cause excess wear to the belt, clutch and engine.**

1. When the mower is in position on the area to be mowed, move the throttle to its full speed.
2. **SLOWLY** push the blade control lever forward into the soft start range.
3. When the blades have reached full speed push the blade control lever fully into the on position.
4. Begin mowing as described on the previous page, always using safe/comfortable speeds.
5. To stop the blades, pull the blade control lever back to the OFF position.



**IMPORTANT!** The mower belts are adjusted to ensure the blades stop turning within seven (7) seconds of releasing the blade control lever. If you are making any belt adjustments whatsoever, for your safety and the safety of others around you, you must ensure the belts are re-adjusted to achieve this design specification.

### Disengaging Hydraulic Drive Units

Before physically moving the mower when the engine is **NOT** running, the hydraulic drive units need to be disengaged into free-wheel mode.

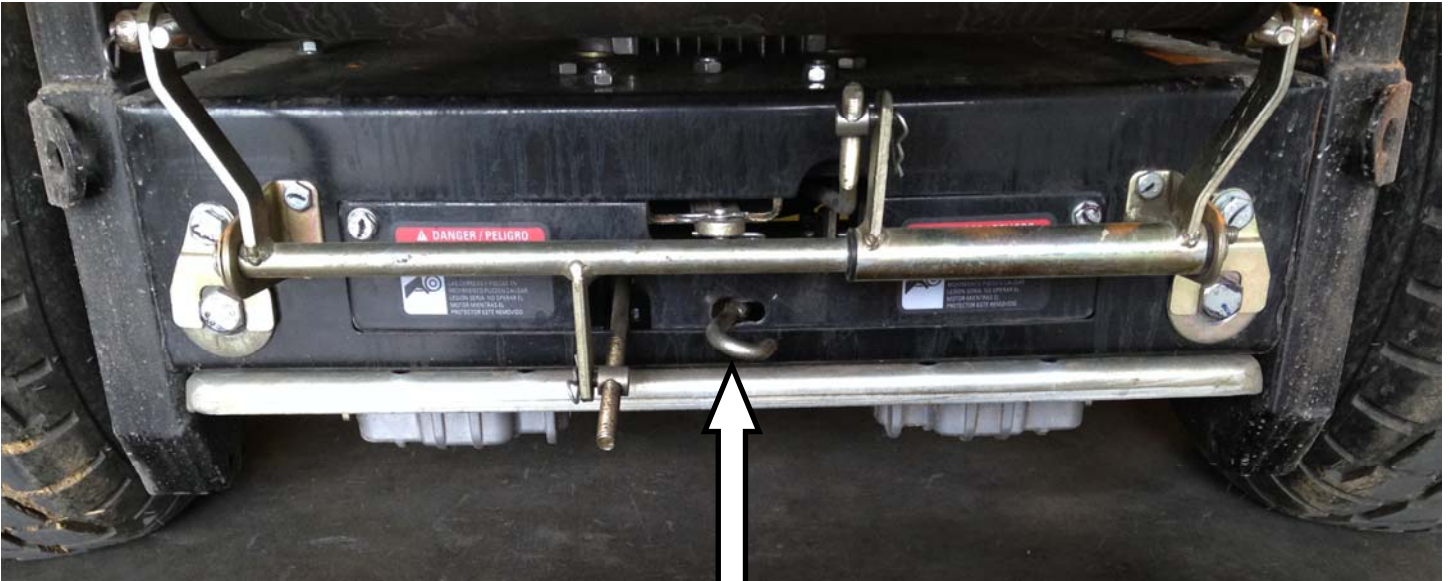

#### To disengage the hydraulic drive units:

1. Stand at the rear of the mower and locate the hydraulic drive disengagement mechanism.
2. Pull the disengagement mechanism outward toward the rear of the mower until the thickened section of the rod is outside of the access panel. (Note this may take a large amount of force as the springs inside are very stiff)

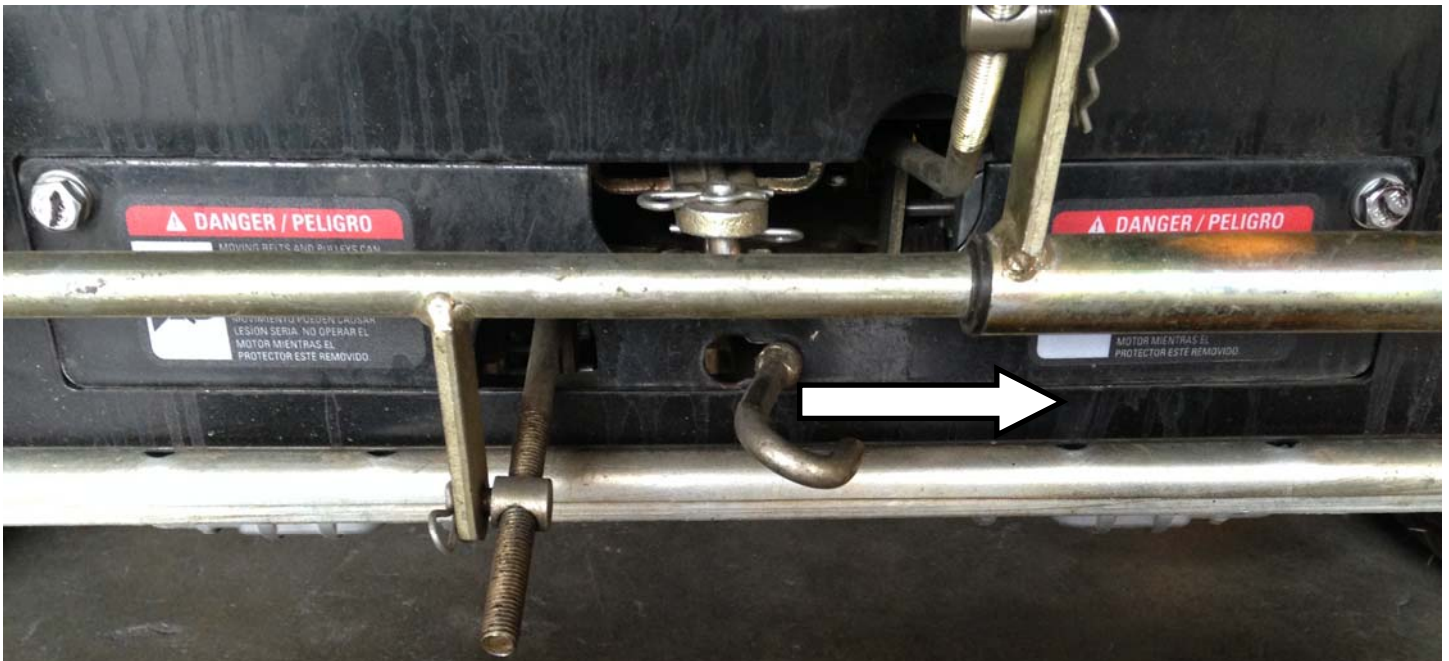

3. Slide the disengagement mechanism to the right so that the thickened section of the rod is captured in the narrow end of the slot. In the lower picture the disengagement mechanism is shown in the disengaged position.
4. To reengage the hydraulic drive units, pull the disengagement mechanism out, slide it to the left, and release. Make sure the thickened section of the rod passes back through the wide end of the slot.

### The Importance of Maintenance

Regular maintenance is essential to ensure your mower continues to deliver safe and high-quality performance.

To help you properly care for your mower, the following pages include a recommended maintenance schedule, routine inspection procedures, and simple maintenance procedures using basic hand tools. Maintenance is the responsibility of the owner and must be performed regularly. More difficult service tasks or tasks that require special tools are best handled by a recommended service technician or other qualified mechanic.

The maintenance schedule described on page 14 applies to mowers used under normal operating conditions. If you operate your mower under severe conditions, such as sustained prolonged use or high-temperature operations, or use it in unusually wet, dusty or rocky conditions, consult your servicing dealer for recommendations applicable to your individual needs and use.

Be sure to use genuine BEAST mower replacement parts when servicing your mower to assure the best quality, safety and performance.

#### Need Help?

For Parts, Service and Technical Assistance call 1-919-550-3221 or 800-393-0668  
Or visit [www.gxioutdoorpower.com](http://www.gxioutdoorpower.com)



**Gasoline is highly flammable and explosive. Do not add fuel while the engine is running or is hot. Keep open flames, sparks, and heat away from the fuel and store fuel in containers specifically designed for that purpose. Add fuel outdoors only and if the fuel is spilled, do not start the engine. Manually push the mower away from the spill and wipe up immediately.**

Refer to the Engine Owner's Manual for the type of fuel to use.

A fuel shut off valve is located on the bottom of the fuel tank. It is recommended that the fuel be shut off when transporting between job sites and when storing the mower for extended periods of time.



**CAUTION!** Before making any adjustments to and/or servicing your BEAST mower, make sure the mower is on a level surface, with the ignition switch off, the key removed, the brake set, and the blades disengaged. Also, disconnect the spark plug wires from the spark plugs and ground them against the engine to prevent inadvertent starting.

If you are performing adjustments or maintenance after operating the mower, allow the unit to cool and always wear protective clothing.

### Tire Pressure

Incorrect tire pressure may cause the mower to pull to one side and/or result in an uneven cut. Use caution when filling the tires. NEVER exceed the recommended maximum tire pressure as stated on the tires.

### Air Filter

Refer to the Engine Owner's Manual for the recommended maintenance.

### Engine Oil

CHECK ENGINE OIL BEFORE EACH USE. Refer to the Engine Owner's Manual for the type of oil to use, oil change intervals, and the proper procedures to check and change oil.

### Blades

Inspect blades on a daily basis for nicks, bends, and excessive wear. If the blades are worn, cracked, bent, or damaged, replace them before using the mower. Choose genuine BEAST mower replacement blades to ensure quality and performance. (See page 23 for blade removal instructions.)

When sharpening the blades, sharpen only the cutting edges and try to maintain the original angle of the blade. Do not make the cutting edge razor sharp. Remove the same amount from each end of the blade so that balance is maintained.



**CAUTION:** Always wear work gloves when performing blade maintenance and beware of the cutting edges. Be sure the engine is off, the key removed, and the spark plug wires are disconnected from the spark plugs to prevent inadvertent starting.

Item	Procedure	Time Interval				
		Break-in (first 5 hrs.)	Every 8 hrs. (daily)	Every 40 hrs. (weekly)	Every 100 hrs. (Bi-weekly)	Every 200 hrs. (monthly)
Belts	Inspect (adjust if needed)	X	X			
Blades	Inspect and/or Sharpen		X			
Engine Air Filter	Inspect (see Engine Owner's Manual)		X			
Engine Cooling Areas	Clean (see Engine Owner's Manual)		X			
Engine Oil	Check (see Engine Owner's Manual)	X	X			
	Change (see Engine Owner's Manual)					
Engine Oil Filter	Change (see Engine Owner's Manual)					
Engine Spark Plug	Inspect (see Engine Owner's Manual)					
Fuel Filter	Replace				X	
Fuel Line	Check				X	
Grease Fittings	Refer to page 19					
Hardware	Check for proper tightness	X		X		
Mower Main Frame	Remove debris from under belt cover		X			
Safety Interlock System	Check Operations and Switches		X			
Tires	Check Air Pressure			X		
Spindle/Blade Brakes			X			

**Cleaning the Mower**

It is recommended that the BEAST lawn mower be cleaned on a daily basis. Excessive accumulation of dirt, debris, oil, etc. on cutting units, drives, mufflers, and engine may present a potential safety hazard. Also refer to the engine owners manual for additional cleaning instructions.

## Return to Neutral



**DANGER!** Make certain the engine comes to a complete stop before putting your hands in the access panel.

If the mower creeps or will not stop as desired when the handles are in neutral position, adjustments are necessary.

**CAUTION:** Be sure the engine is OFF before you open the hydraulic drive access panel.

1. Remove the bolts to access hydraulic drive access panel.
2. Using an 8 mm wrench, reach through the bottom of the hydraulic drive access panel to the return-to-neutral set pin bolts. Loosen bolts on the side that needs adjusting.
3. Be sure the brake is in the OFF position. In a safe operator position, start the engine.
4. With the engine running, slowly move the handle on the side needing adjustment until that side comes to a complete stop. If the mower creeps forward, pull handle in reverse, If the mower creeps backward, pull the handle forward.
5. When the mower stops moving completely, the hydraulic drive is in the neutral position.
6. Turn off the engine.
7. Slowly tighten the bolts without moving the plate.
8. With the bolts tightened, move to a safe operator position and start the engine.
9. If the creep has returned, repeat the process. Multiple iterations may be required.
10. Reinstall hydraulic drive access panel.

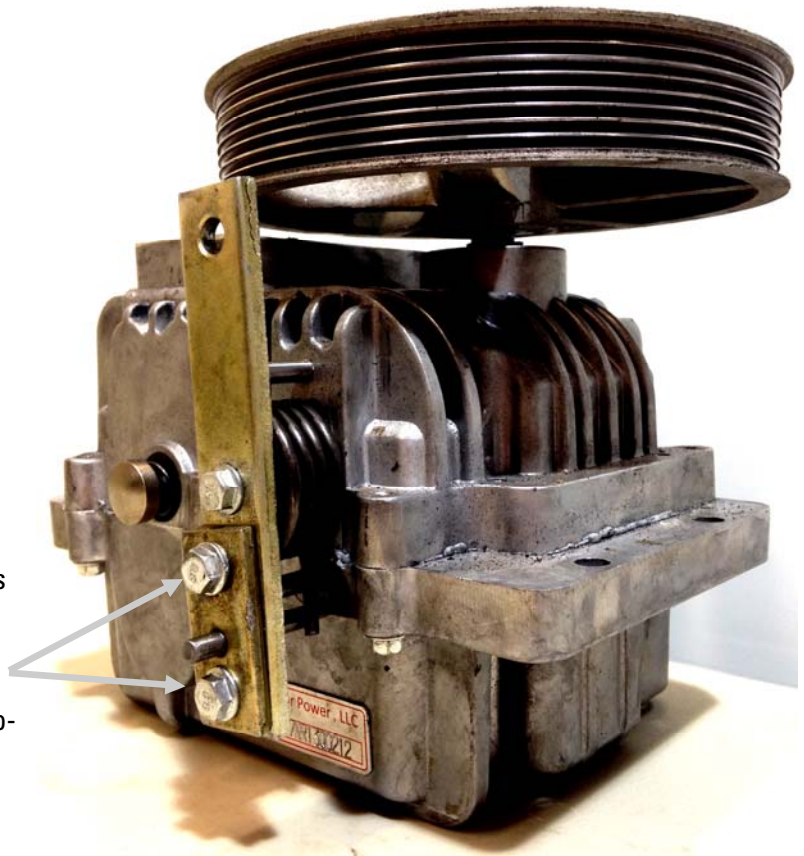

## Deck Belt Tension

It is recommended to check and adjust the deck belt tension after the initial 5 hours of use on the hour meter. The new belt will seat into pulley grooves and may need adjusting. After the initial break in period, it is recommended to inspect belt tension every 8 hours and adjust if necessary. Follow the steps below to inspect belt tension. Follow ALL safety precautions mentioned in this manual when doing any maintenance on your mower.

**Note:** Failure to inspect and adjust the deck belt tension can result in poor mowing performance and pre-mature belt wear.



**DANGER:** Before making any adjustments or servicing your mower, make sure the mower is on level ground, the blades are disengaged, the brake set, the key is removed, the engine is off and the spark plug wires are disconnected from the spark plugs to prevent inadvertent starting. If maintenance or adjustments are being performed after operation of the mower, allow the unit to cool since heat build up could cause severe burns.

### Figure 1

- Ensure the blade engagement handle is in the "OFF" position.
- Set your deck height to its LOWEST setting (1.5 inches)
- Open the floorboard and locate the idle/clutch pulley (1) and turnbuckle (2).
- Check the clutch linkage pre-load.
- If the threaded rod and spring assembly (3 & 4) is too tight, the clutch will not contact the return stop bolt (5). The clutch pivot arm (6) should stop within a 1/4" of the stop bolt (5).
- If the threaded rod and spring assembly (3 & 4) is too loose, the spring will contact the deck surface.
- To adjust the pre-load, remove the cotter pin from the slack adjuster on the threaded rod (3) and slide the linkage off the arm (7). Thread the linkage pivot in or out to set pre-load as stated above.

Figure 1

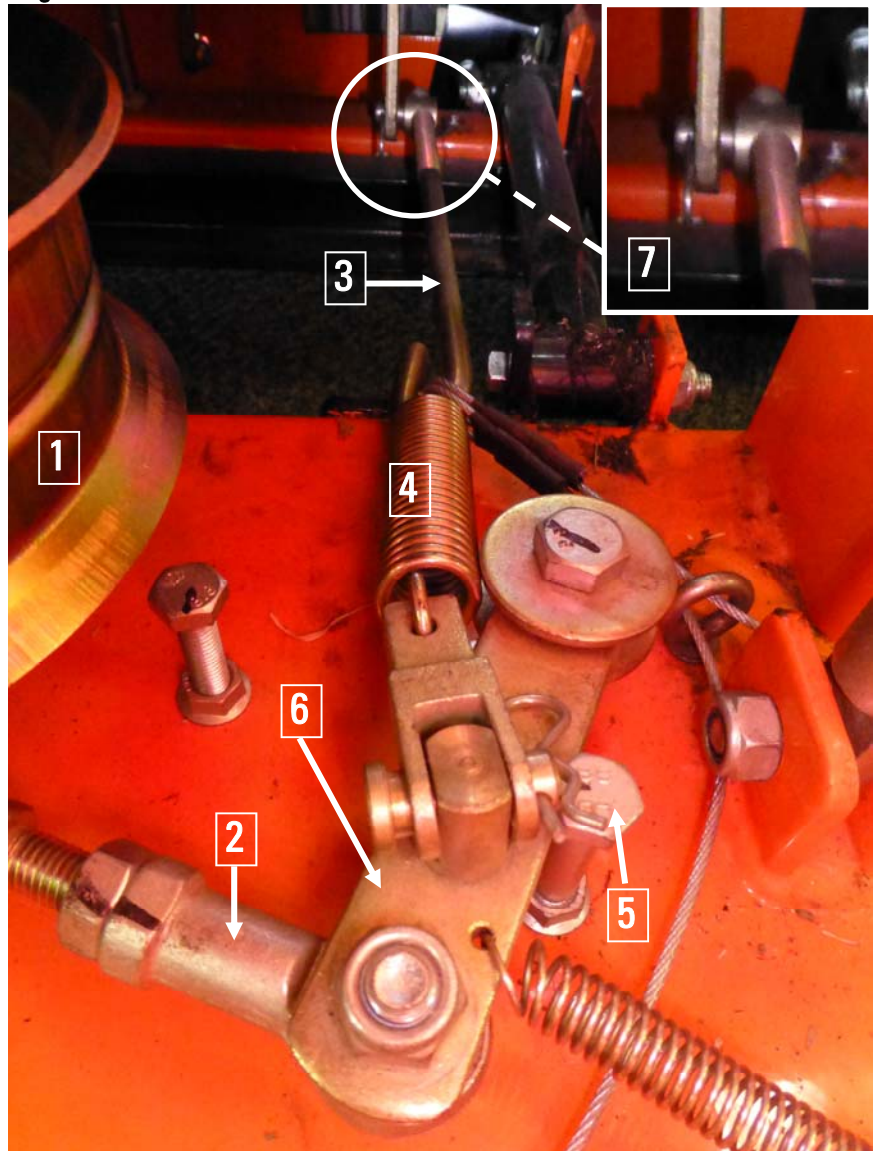

Deck Belt Tension



It is recommended to check and adjust the deck belt tension after the initial 5 hours of use on the hour meter. The new belt will seat into pulley grooves and may need adjusting. After the initial break in period, it is recommended to inspect belt tension and adjust if necessary every 8 hours. Follow the steps below to inspect belt tension. Follow ALL safety precautions mentioned in this manual when doing any maintenance on your mower.

**Note: Failure to inspect and adjust the deck belt tension can result in poor mowing performance and pre-mature belt wear.**

**DANGER:** Before making any adjustments or servicing your mower, make sure the mower is on level ground, the blades are disengaged, the brake set, the key is removed, the engine is off and the spark plug wires are disconnected from the spark plugs to prevent inadvertent starting. If maintenance or adjustments are being performed after operation of the mower, allow the unit to cool since heat build up could cause severe burns.

Figure 2

- Move the blade engagement handle to the "ON" position.
- Using your hand, press the clutch pulley (7) in the direction indicated with about 20-25lbs of pressure. Ensure that the swing arm(8) stops within 1 inch to 1.5 inches from the stop bolt(9).

Figure 2

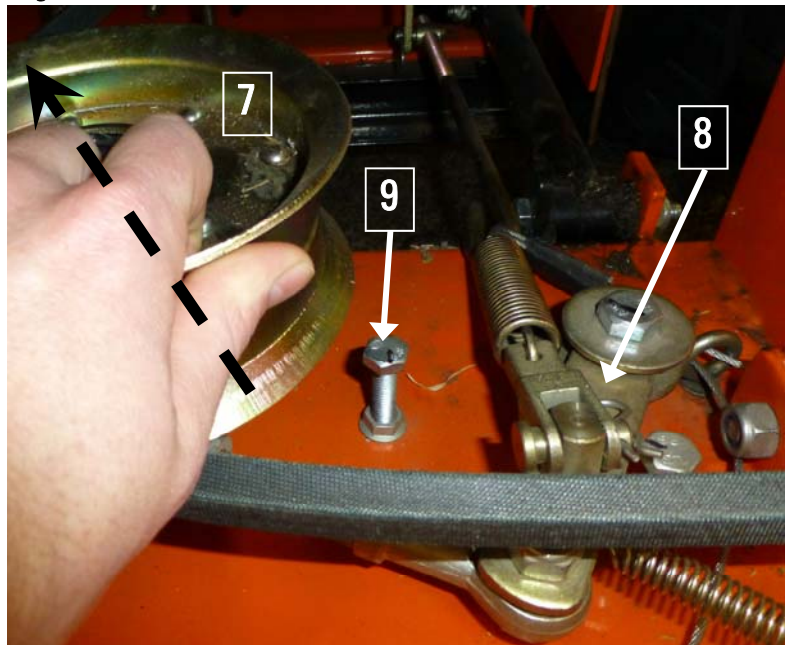
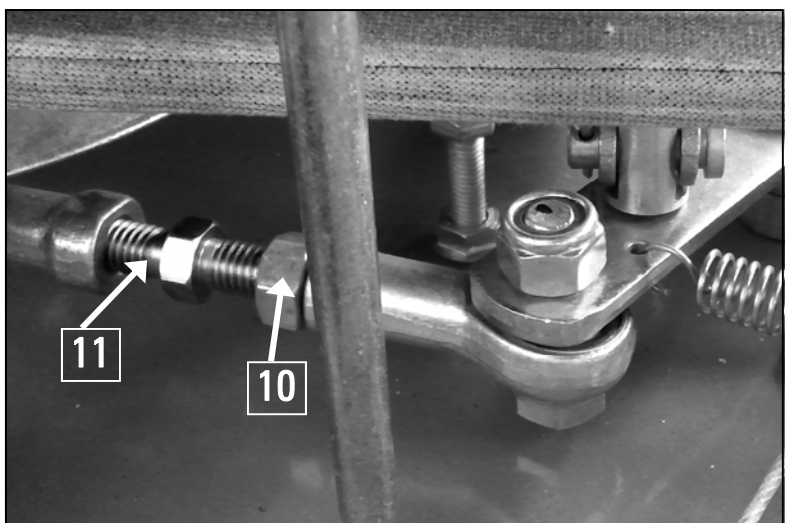

Figure 3

- If the swing arm reaches the stop bolt, the tension is too loose. Move the blade engagement handle to the "OFF" position. Loosen the turn-buckle locknut (10). Adjust the turnbuckle linkage (11), extending the pulley. Move the blade engagement handle back to the "ON" position and repeat test by applying 20-25 lbs of pressure and check the stop bolt clearance. The swing arm should be 1" - 1.5" away from the stop bolt.
- If the swing arm has a clearance greater than 1.5" the tension is too tight. This may result in pre-mature belt wear as well excess stress on the springs of the clutch. Adjust the turnbuckle as mentioned above.

Figure 3





**Deck Belt**



It is recommended to do a quick visual inspection of the deck belt retainers at the same interval as inspecting the deck belt tension. This check should be performed every 8 hours. The engine pulley retainer should be inspected when replacing the deck belt, or if the belt is slipping off the engine pulley.

**DANGER:** Before making any adjustments or servicing your mower, make sure the mower is on level ground, the blades are disengaged, the brake set, the key is removed, the engine is off and the spark plug wires are disconnected from the spark plugs to prevent inadvertent starting. If maintenance or adjustments are being performed after operation of the mower, allow the unit to cool since heat build up could cause severe burns.

**Deck Belt Routing**

**54ZB**

- Serial #s beginning with 54ZB10XXX use a MXV5 1430 V Belt.
- All other serial #s use a MXV5 1520 V Belt.

**62ZB**

- Serial #s beginning with 62ZB10XXX use a MXV5 1630 V Belt.
- All other serial #s use a MXV5 1680 V Belt

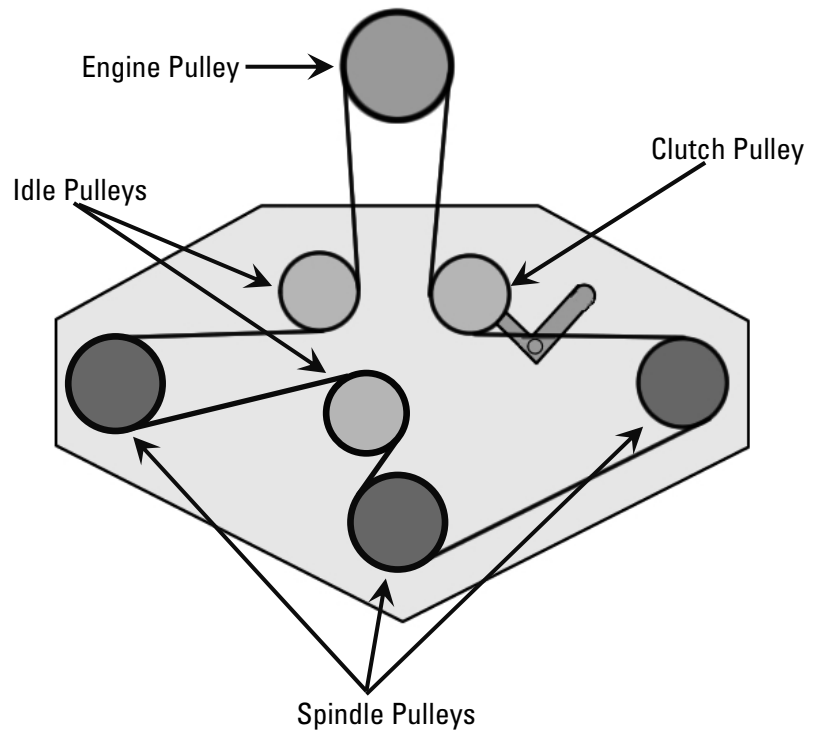

**Deck Belt Retainers**

There are 8 main deck retainers.

- 6 "J" shaped retainers (1, 2, 3, 4, 5, 6)
- 2 idle pulley retainers (7)
- To adjust the retainers, loosen the top nut slightly and rotate the retainer into place. After adjusting hold the retainer in place and tighten the nut.

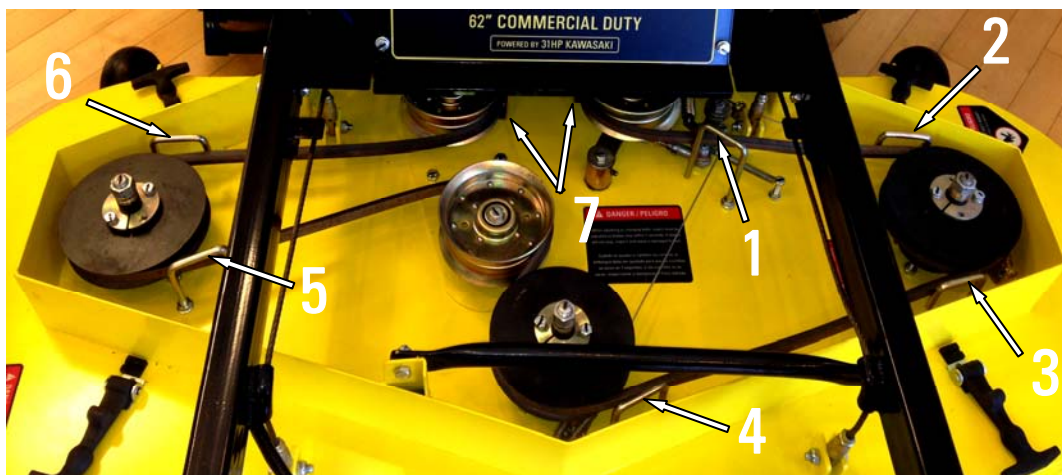

## Deck Belt

Follow ALL safety precautions mentioned in this manual when doing any maintenance on your mower.

The clearances for the retainers are listed below, and measured with the blades engaged and engine OFF.

### Verifying Deck Belt Retainers

Figure 1:

- The clearance for the "J" shaped retainers is 3/16"
- To adjust the retainers, loosen the top nut slightly and rotate into position. Hold the retainer in place while retightening the nut

Figure 2:

- The clearance for the idle pulley retainers is 1/8"
- To adjust the idle pulley retainers, loosen the nut on the top of the pulley and bottom slightly. Slide the retainer into place and tighten the nut back.

Figure 3

- A line drawn from the center of the deck clutch pulley to its belt retainer should be parallel to the rear of the deck when the blades are not engaged.
- To adjust the position of the deck clutch pulley belt retainer, loosen the bolt slightly. Pivot the retainer into place and retighten the bolt.

**DANGER:** Before making any adjustments or servicing your mower, make sure the mower is on level ground, the blades are disengaged, the brake set, the key is removed, the engine is off and the spark plug wires are disconnected from the spark plugs to prevent inadvertent starting. If maintenance or adjustments are being performed after operation of the mower, allow the unit to cool since heat build up could cause severe burns.

Figure 1

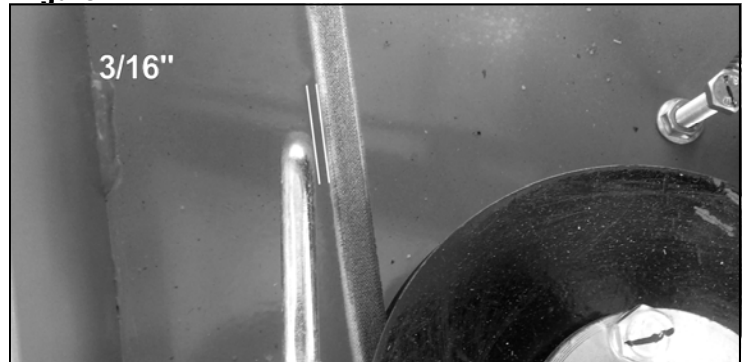

Figure 2

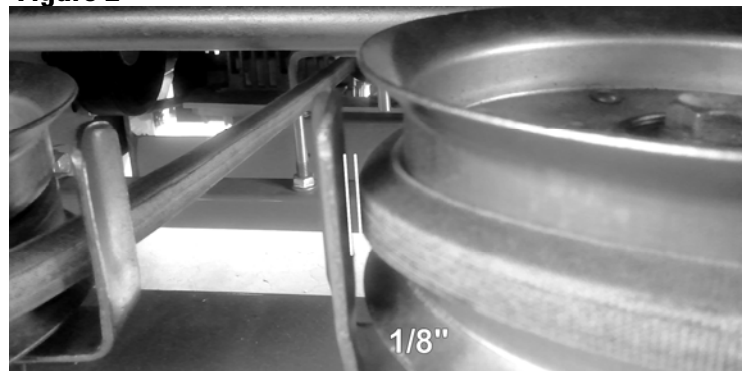
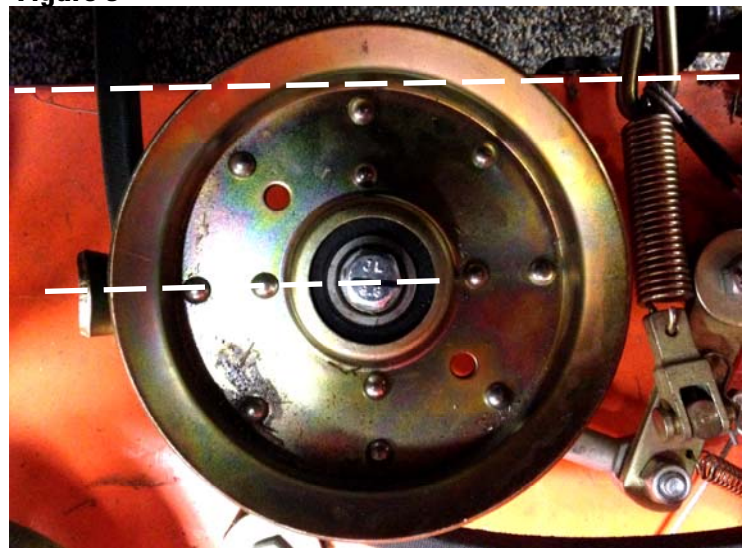

Figure 3



**Spindle Brake Inspection and Replacement**

**IMPORTANT!** The mower belts are adjusted to ensure the blades stop turning within seven (7) seconds of releasing the blade control lever. If you are making any belt adjustments whatsoever, for your safety and the safety of others around you, you must ensure the belts are re-adjusted to achieve this design specification.

**Blade and pulley brake inspections should be performed every 100 blade on and off cycles.**

Before beginning service, park the mower on a level surface, turn the blades off, turn the engine off, set the brake, take the key out of the switch, wait an adequate time to make certain no blades are turning, and remove spark plug wires from spark plugs.

1. Engage the blade handle (make certain the engine cannot start) to pull the brakes off of the pulleys.
2. Remove the pulley guards from the deck.
3. Visually inspect the brake pads for wear. Make certain that no metal is touching the pulleys.

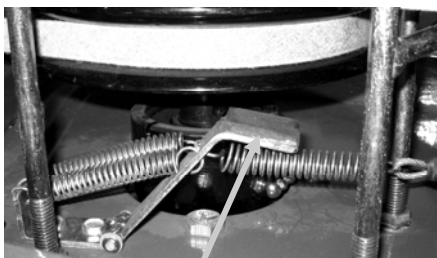

4. The brake pad material should be approximately 1/8-inch thick. Replace the brakes if the material is less than 1/16-inch thick.

**Note:** Replacing all brake pads is recommended if replacement of one brake is required.

5. To replace the brake, use a pair of pliers to remove the springs.
6. Remove the two mounting bolts and disconnect the spring from the cable.
7. Discard all of these parts. **DO NOT** reuse springs. New brakes are equipped with new springs for proper braking.
8. Install the new brakes by reversing the procedure in steps 5 and 6.
9. Disengage the blade handle and inspect the brake contact surface. All of the brake pad contacting material should be contacting the bottom of the pulley.

**Note:** Springs may vary from those pictured based on the particular application.

**Removing the Blades**

4. **Required tools:** 18mm Wrench



**CAUTION!** Beware of the cutting edges on the blades. The rotation of one blade may cause the other blades to rotate. Always wear work gloves when handling blades.

1. Park the mower on level ground, set the brake and block the rear wheels to prevent accidental rollback.
2. Raise the front end of the mower and place on a jack stand.
3. Use one wrench to loosen nut A while carefully holding the blade.

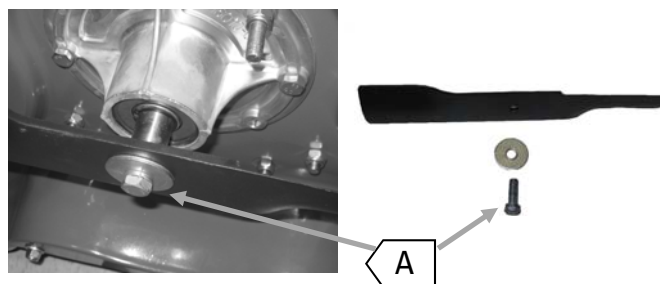

4. To reinstall, insert the bolt with lock washer and large flat washer into the spindle.
5. **IMPORTANT:** The number of spacers should always be the same on each blade bolt. **NEVER** put the spacers below the blade and **NEVER** straighten or weld the blades.

**IMPORTANT!** The mower belts are adjusted to ensure the blades stop turning within 7 seconds of releasing the blade control lever. If you are making any belt adjustments whatsoever, for your safety and the safety of others around you, you must ensure the belts are re-adjusted to achieve this design specification.

**Engine-to-Hydraulic Drives Belt Adjustment (Hydraulic drive Input Belt)**

- The hydraulic drive input belt is located underneath the chassis at the rear of the mower. The belt should move approximately 1/8 to 3/16-inch with three (3) to five (5) pounds of pressure applied to the belt midway between the hydraulic drive pulleys when initially installed. After approximately 1 hour of running time, verify that the belt tension is still correct and tighten if necessary

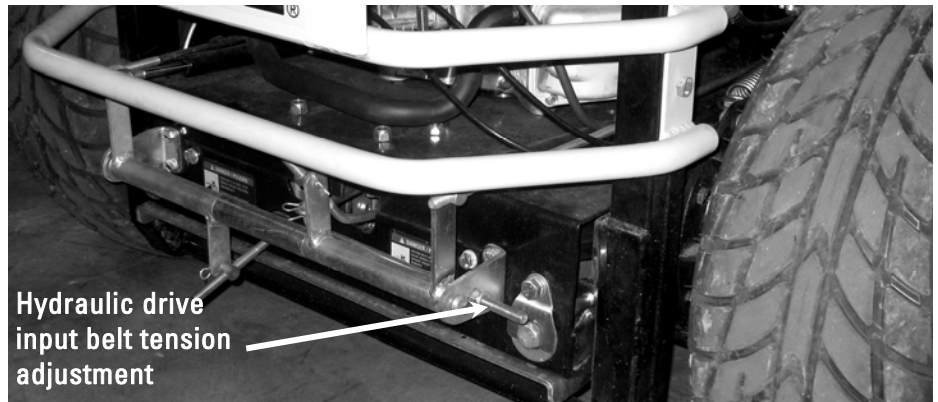

**Important:** Do not over-tighten the belt.

- To adjust the belt, turn the nut on the threaded tension rod found on the right, rear corner of the mower.
- Do not over-tighten. This could cause damage to the hydraulic drive systems.
- The hydraulic drive input belt is an 8PK 1690 multi ribbed v belt. GXi part number M10-000469.

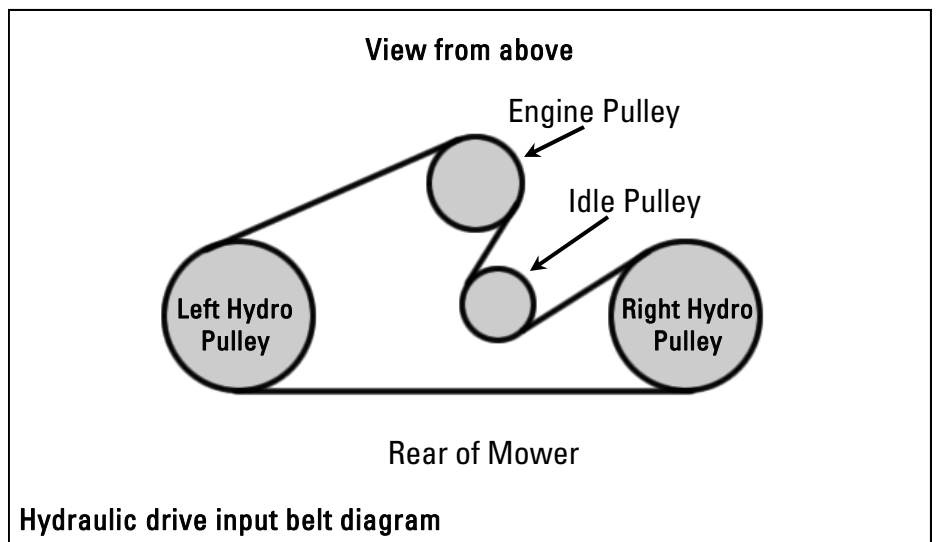

**Hydraulic Drive System Adjustment**

The hydraulic drives are coupled to the final drives with a multi-v belt. Occasional re-tensioning of the belt may be necessary. If performance decreases or hydraulic drive control handles are activated and the wheels do not turn, inspect the multi-v belt. **Before beginning the following test, read all warnings in this manual. If you are uncomfortable with this procedure please contact GXi to be set up for service.**

**Normal service interval: seasonally or every 100 hrs.**

Adjust the hydraulic drive adjustment bolts by tightening the two large 21mm nuts on the rear of the mower. Tighten the final drive belt so there is approximately 3/4" belt deflection in the center of the belt with about 10lbs of pressure applied.

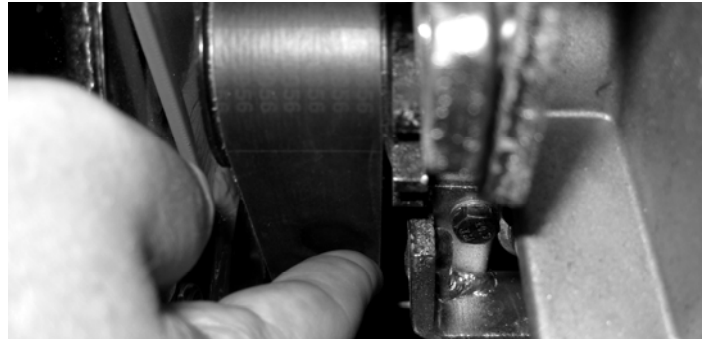
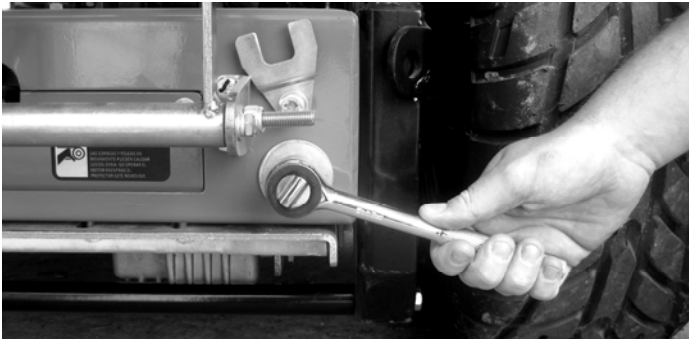

The next step is to perform a "wall test." Drive the mower against a padded stationary object. For accurate results, a smooth brushed concrete surface works best. Stand next to the mower with one hand on the seat. Start the mower with one hand on the seat to engage the safety switch. Engage the left side handle into the drive position. Quickly move the handle to full forward position for about half a second. Now perform the same procedure on the right side. If the belt squeals and the wheel does not spin on either side, tighten each adjustment bolt one **half** turn. Always turn both bolts the same amount whenever adjustment is required. Repeat the test until both tires will break traction and spin.

Once you have the tension set so each wheel will just barely break traction, mark the bolt on one side of the hex head as shown. Now tighten the bolt (turn clockwise) one sixth of a turn. This will set tension so the belt does not squeal, and provides ample torque for driving and mowing without causing belt or hydraulic drive damage.

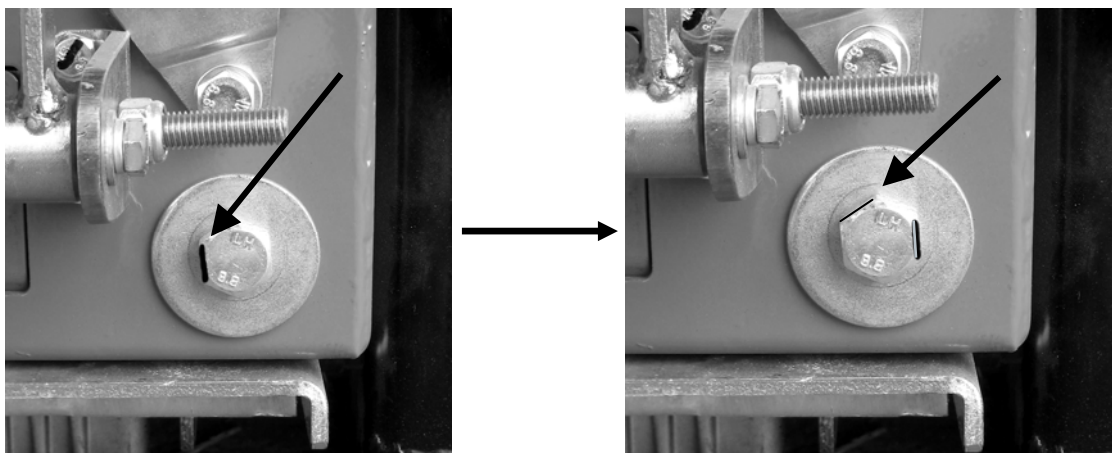

Now drive the mower on a grassy surface. Perform several Zero Turns. Drive the unit aggressively. If the performance is "sloppy" or you have excessive belt chirping, **tighten** the bolt 1/6th of a rotation and re-test. Re-Install the adjustment bolt retainer clips after adjustments.

If the mower is too nimble, or you want to reduce the power output to prevent damage to the turf, **loosen** the bolt 1/6th of a rotation and re-test. Occasional belt chirping is permitted. If the belt squeals excessively tighten 1/6th of a rotation and re-test.

### Safety System Adjustments



**WARNING:** Do not bypass, modify, alter, or disconnect the safety system. Make sure that the safety interlock system is fully operational each time before mowing. Failure to do so could present danger to you and others around you.

There are generally three (3) ways to adjust the sensitivity of a safety switch. The most appropriate way to adjust each switch depends upon the application, location, and the nature of the problem you are encountering.

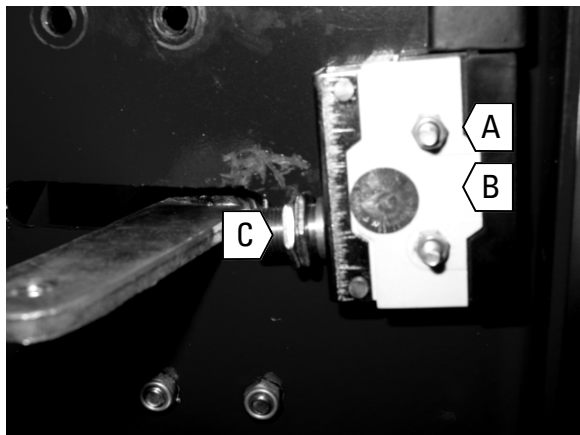

#### Method 1: Adjust location using the mounting screws

1. Move the blade control lever to OFF.
2. Loosen screws (A) until safety switch (B) moves freely.
3. Slide safety switch (B) firmly against blade bell crank (C).
4. Tighten screws (A) and check that safety switch (B) does not move.

#### Method 2: Adjust location using adjustment nuts on switch body

1. Loosen locking nut (C) on the sensor shaft.
2. Adjust switch location by turning the nuts.
3. Tighten the locking nut when proper adjustment is achieved.

### Tracking Adjustments



**WARNING!** ALLOW THE MUFFLER TO COOL BEFORE MAKING THIS ADJUSTMENT! This adjustment is made in close proximity to the muffler. The muffler can reach extremely hot temperatures and can burn you instantly on contact.

#### For mowers with serial numbers 54ZB18XXXX and 62ZB18XXXX:

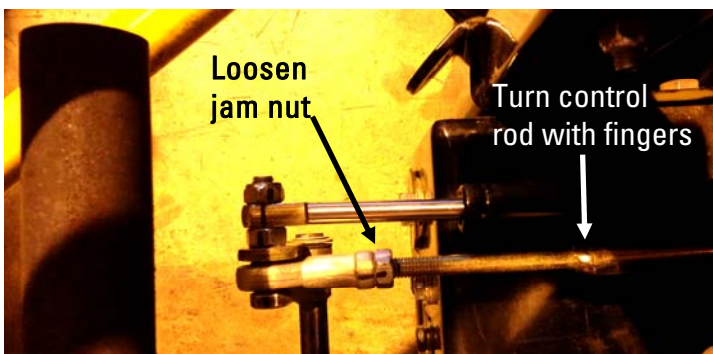

1. Loosen the jam nut on the control rod on the side that is moving slower.
2. Turn the control rod one turn clockwise while facing the rear of the mower.
3. Tighten the jam nut.
4. Drive mower in straight line and adjust again if necessary.

#### For mowers with all other serial numbers:

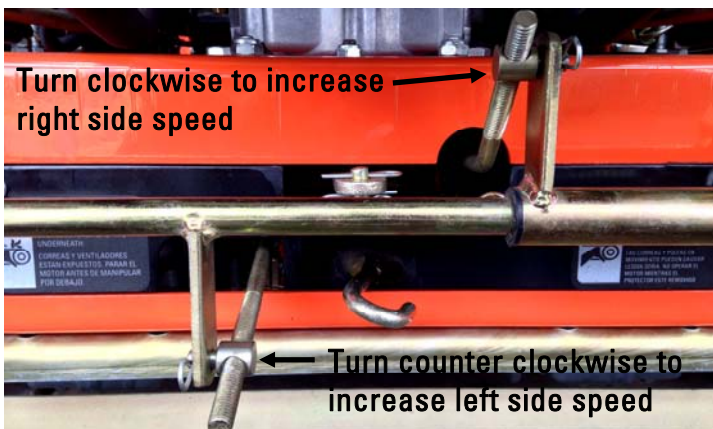

Remove pin and turn adjuster one turn at a time until mower tracks straight.

**Lubrication**

To ensure proper lubrication of moving parts, GXi recommends that you lubricate the following components with a high-quality, EP2 high-temperature-based grease or equivalent. Should the conditions of operation be more severe than normal, the lubrication interval may need to be shortened. GTR/OPE grease is the recommended lubricant.

**Lubrication Point Locations**

54-inch & 62-inch mowers have 8 lubrication points.

**Lubricate after every 50 hours of usage**

1. Front wheels (2 locations, 1 on each wheel shaft)



2. Mower deck clutch pulley pivot.



**Changing Battery**

When disconnecting the battery make sure to disconnect the negative terminal first and the positive last. When reconnecting, connect the positive first and the negative last.



**These batteries are compatible with your mower**

Note: some may require that you change terminals

Battery	Part #	Store	Terminal Part #
U1-3	U1-3	Advance Auto Parts	AC171/A1500102
GT-XHD-MT	4700042	Tractor Supply	
10U1L	543215	Lowe's	
BCI#U1	BAT 8229	NAPA	NW 728248
U1-3	U1-3	AutoZone	6069
U1LUH	U1LUH	O'Reilly Auto Parts	SK7401

**Charging Battery**

Always charge battery in an open well ventilated area, away from sparks and flames. Unplug charger before connecting or disconnecting from battery and always wear protective clothing and use insulated tools.



**DANGER:** Battery electrolyte has sulfuric acid which can cause severe burns and is a deadly poison. Never drink and always avoid contact by wearing gloves and safety glasses when servicing the battery.



**WARNING:** Do not allow battery terminals to touch any metal parts of the mower when removing the battery. Never allow metal tools to short between the battery terminals and metal parts of the mower as this may cause sparks. Sparks can also cause the battery gasses to explode which can result in injury/death.

**Short Term Storage**

- Let engine cool before storing and do not store near flame, high heat, and possible ignitions from sparks.
- Always clean off all flammable material as well as grime and dirt before storage.
- Never use a pressure washer and avoid drenching the control panel, motor, engine, and hydraulic drive pumps with water.
- Wash with mild detergent and water only.
- After washing the machine engage the engine at high and let the mower run for 5 minutes.
- Shut off fuel for storing or transporting.
- Carefully release pressure from components with stored energy.
- Store mower only on the ground.
- Do not drain fuel indoors or near a flame.
- Use jack stands to support components when required.
- Always park machine on level ground and set the parking brake when storing.
- Store the machine in a clean and dry environment.
- Always remove the key from the ignition.
- Add a petroleum based conditioner in the gas tank and run for 5 minutes to distribute through mower.

**Extended Storage**

In addition to the measures taken for short term storage, the following measures should be taken for long term storage:

- Change air filter.
- Make sure all fuel is drained before storing.
- To ensure all fuel is drained from the mower, run the mower until it runs out of gas before storage.
- Check the spark plugs condition and pour two tablespoons of engine oil in the spark plug holes and leave the spark plugs off.
- Cover the machine when in storage.
- Remove Battery and clean terminals and cable connectors. Store battery in a cool dry place.



<b>Problem</b>	<b>Possible Causes</b>	<b>Solution</b>
Engine will not start	<ol style="list-style-type: none"> <li>1. Key in the OFF position</li> <li>2. Insufficient fuel in the tank</li> <li>3. Air bubble in the fuel line</li> <li>4. Fuel valve in OFF position</li> <li>5. Choke not ON</li> <li>6. Choke linkage out of adjustment</li> <li>7. Low engine oil</li> <li>8. Blade control in ON position</li> <li>9. Loose spark plug wire</li> <li>10. Fouled spark plug</li> <li>11. Plugged or dirty air filter</li> <li>12. Bad gasoline</li> <li>13. Plugged or dirty fuel filter</li> <li>14. Safety switches out of alignment or loose</li> <li>15. Dead battery (electric start models)</li> </ol>	<ol style="list-style-type: none"> <li>1. Turn key to ON position</li> <li>2. Add gasoline</li> <li>3. Prime engine or shake bubble out</li> <li>4. Turn valve ON</li> <li>5. Turn choke ON</li> <li>6. Refer to Engine Owner's Manual</li> <li>7. Add engine oil</li> <li>8. Push lever to OFF position</li> <li>9. Tighten wire or connections</li> <li>10. Clean or replace the plug</li> <li>11. Clean or replace the air filter</li> <li>12. Drain and replace with fresh gasoline</li> <li>13. Replace the fuel filter</li> <li>14. Adjust or tighten switches (p. 26) - read warnings!</li> <li>15. Recharge or replace battery</li> </ol>
Engine will not keep running/quits	<ol style="list-style-type: none"> <li>1. Water in the fuel</li> <li>2. Loose safety switch</li> <li>3. Fuel valve is OFF</li> <li>4. Dirty fuel filter</li> <li>5. Dirty air filter</li> <li>6. Low engine oil</li> </ol>	<ol style="list-style-type: none"> <li>1. Drain and replace with fresh fuel</li> <li>2. Adjust switch (p. 26)</li> <li>3. Turn fuel valve ON</li> <li>4. Replace fuel filter</li> <li>5. Clean or replace air filter</li> <li>6. Add engine oil</li> </ol>
Engine stops when blades are engaged	<ol style="list-style-type: none"> <li>1. Loose safety switch</li> <li>2. Belt tension too high</li> <li>3. Blades jammed with foreign material</li> </ol>	<ol style="list-style-type: none"> <li>1. Adjust switch (p. 26)</li> <li>2. Adjust belt (p. 20)</li> <li>3. Remove foreign material</li> </ol> <p><b>Note:</b> Firmly pushing the blade control lever into the OFF position to ensure the safety switch is fully engaged can sometimes resolve this problem.</p>
Blades do not turn	<ol style="list-style-type: none"> <li>1. Broken belt</li> <li>2. Loose belt</li> <li>3. Blade activation linkage out of adjustment.</li> </ol>	<ol style="list-style-type: none"> <li>1. Replace belt</li> <li>2. Adjust belt (p. 20)</li> <li>3. Adjust linkage (p. 19)</li> </ol>
Belts squeal when blades are engaged	<ol style="list-style-type: none"> <li>1. Incorrect belt tension</li> <li>2. Excessive belt wear</li> </ol>	<ol style="list-style-type: none"> <li>1. Adjust belt tension</li> <li>2. Replace belt</li> </ol>
Belts slip when blades are engaged	<ol style="list-style-type: none"> <li>1. Incorrect belt tension</li> <li>2. Excessive belt wear</li> </ol>	<ol style="list-style-type: none"> <li>1. Adjust belt tension</li> <li>2. Replace belt</li> </ol>

<b>Problem</b>	<b>Possible Causes</b>	<b>Solution</b>
Mower will not move forward or reverse	<ol style="list-style-type: none"> <li>1. Brake ON</li> <li>2. Bypass levers pulled out</li> <li>3. Hydraulic drive oil has not reached optimal temperature.</li> </ol>	<ol style="list-style-type: none"> <li>1. Release brake on control panel</li> <li>2. Ensure bypass pins are retracted</li> <li>3. Allow 5 to 10 minutes for hydraulic drive oil to warm up.</li> </ol>
Cannot move mower when the engine is off	<ol style="list-style-type: none"> <li>1. Bypass not engaged</li> </ol>	<ol style="list-style-type: none"> <li>1. Pull bypass rod and set it in the slot in the chassis (p. 15)</li> </ol>
Engine is overheating	<ol style="list-style-type: none"> <li>1. Dirt in the fuel line</li> <li>2. Dirty air filter</li> <li>3. Low engine oil</li> <li>4. Fouled spark plug</li> <li>5. Misuse of the mower</li> <li>6. Dull blades</li> <li>7. Spindle bearing failure</li> </ol>	<ol style="list-style-type: none"> <li>1. Replace fuel filter and flush tank</li> <li>2. Clean or replace the air filter</li> <li>3. Add engine oil</li> <li>4. Replace spark plug</li> <li>5. Mow slower, wait for grass to dry out</li> <li>6. Sharpen cutting blades</li> <li>7. Take in for service</li> </ol>
Grass not cut smoothly or cleanly	<ol style="list-style-type: none"> <li>1. Dull blades</li> <li>2. Mowing too fast for conditions</li> <li>3. Grass is wet or bent over</li> <li>4. Blade is bent</li> <li>5. Tire pressure not equal</li> <li>6. Deck is set at uneven heights</li> <li>7. Blades are set upside down</li> <li>8. Excessive grass and debris build up underneath the deck</li> </ol>	<ol style="list-style-type: none"> <li>1. Sharpen blades</li> <li>2. Slow down while cutting</li> <li>3. Let grass dry to stand up</li> <li>4. Replace blade</li> <li>5. Add air pressure to low tires</li> <li>6. Set deck at equal heights</li> <li>7. Take blades off and install correctly</li> <li>8. Clean out debris</li> </ol>
Mower always pulls to one side	<ol style="list-style-type: none"> <li>1. Controls out of adjustment</li> <li>2. Transmission failure</li> </ol>	<ol style="list-style-type: none"> <li>1. Make tracking adjustment (p. 26)</li> <li>2. Take in for service</li> </ol>

Products Covered by this Warranty	Length of Warranty: *(from the date of original retail purchase)		
	Residential	Commercial	Rental
Engine	Manufacturer's warranty	Manufacturer's warranty	Manufacturer's warranty
Transmission	Manufacturer's warranty	Manufacturer's warranty	Manufacturer's warranty
Mower frame	Lifetime (original owner only)	Lifetime (original owner only)	90 days
Belts, Tires, Battery	90 days	90 days	90 days
Attachments	1 yr limited	1 yr limited	30 day limited

\*LENGTH OF WARRANTY: Batteries supplied with applicable products as standard, original equipment are covered by this warranty for a period of 90 days from the date of original retail product purchase. Consumable parts such as oil, spark plugs, filters, and blades are not covered by this warranty.

**To Qualify for this Warranty**

The product must be purchased in the United States from a dealer authorized by GXi Outdoor Power, LLC to sell those products. This warranty applies to first retail purchaser/owner during the applicable warranty time period. **SAVE YOUR PROOF OF PURCHASE RECEIPT. MUST HAVE PROOF OF PURCHASE TO OBTAIN WARRANTY.**

**What GXi Outdoor Power Will Repair or Replace under Warranty**

GXi will repair or replace, at its option, any part that is proven to be **defective in material or workmanship** under normal use during the applicable warranty time period subject to the exclusions stated herein. This warranty is void if the owner fails to follow the prescribed maintenance and operating procedures described in this manual. This specifically refers to ensuring routine lubrications and oil changes are made, that fuel stabilizer is used when the product is stored and that the product is not overloaded.

GXi has the right to recover warranty administration costs from the owner if the root cause of the malfunction is found to be other than defective material or workmanship. In particular, this warranty does not cover: contaminants in the fuel or oil; damage caused by not following the prescribed warnings and operating practices; failure to follow proper maintenance and storage procedures; and physical damage due to misuse, shipping, handling or storage.

Warranty repairs will be made without charge for parts and labor for the first year.

Anything replaced under warranty becomes the property of GXi. Parts replaced under warranty will be considered as part of the original product and any warranty on those parts will expire coincident with the original product warranty.

**To Obtain Warranty Service**

You must take the BEAST product, accessory, replacement part, apparel or the power equipment on which the accessory or replacement part is installed, and proof of purchase, at your expense, to any BEAST service location in the United States, who is authorized to service that product, during the service location's normal business hours. If you are unable to obtain warranty service, or are dissatisfied with the warranty service you receive, take the following steps: First, contact the manager of the service center involved; normally this will resolve the problem. However, if you should require further assistance, write or call the GXi Parts & Service, LLC 1-919-550-3221. You are responsible for transporting your BEAST product to and from the service center. GXi Parts & Service can arrange for pickup and delivery if the service center provides this service, at your expense.

**Exclusions**

This warranty does not cover: normal wear, contaminants in the fuel or oil; damage as a result of use in an application for which the product was not designed; damage caused by incorporation or use of unsuitable attachments or parts, unauthorized alteration, or other misuse and neglect; damage caused by failure to follow the prescribed warnings, operating practices, proper maintenance and storage procedures; parts affected or damaged by accident and/or collision; damage due to shipping, handling, storage or any causes other than defects in material or workmanship of the product. The customer is responsible for transporting the mower to the service center. Pick Up & Delivery will depend on if the service center provides this service, and will be made at the owner's expense.

**Disclaimer of Consequential Damage and Limitation of Implied Warranties**

GXi disclaims any responsibility for loss of time or use of the product, transportation, commercial loss, or any other incidental or consequential damage. Any implied warranties are limited to the duration of this written limited warranty.

**THIS WARRANTY IS VOID IF THE MANUFACTURING DATE AND THE SERIAL NUMBER ON THE EQUIPMENT HAS BEEN REMOVED OR THE EQUIPMENT HAS BEEN MODIFIED.**

### ZTR Mower Quick Start Guide

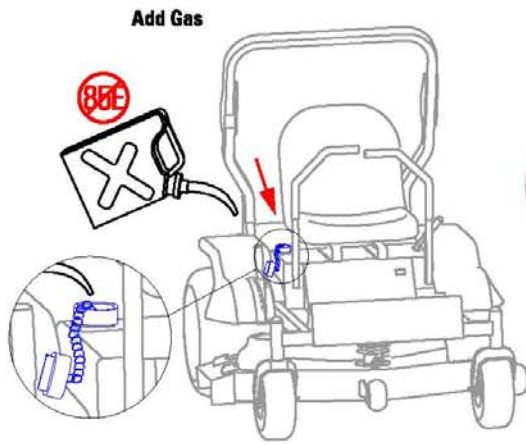

①

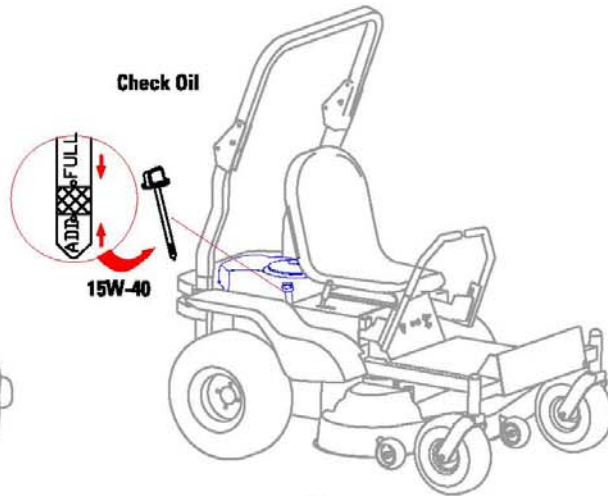

②

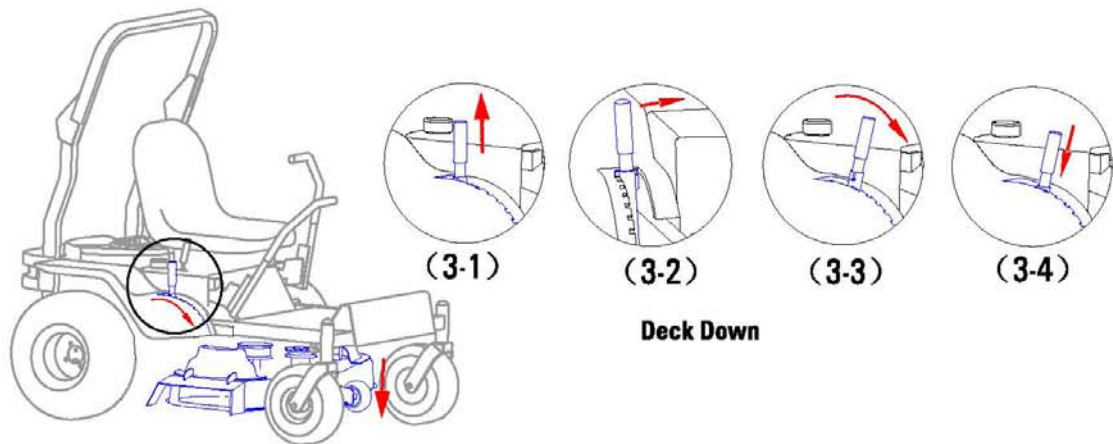

③

Deck Down

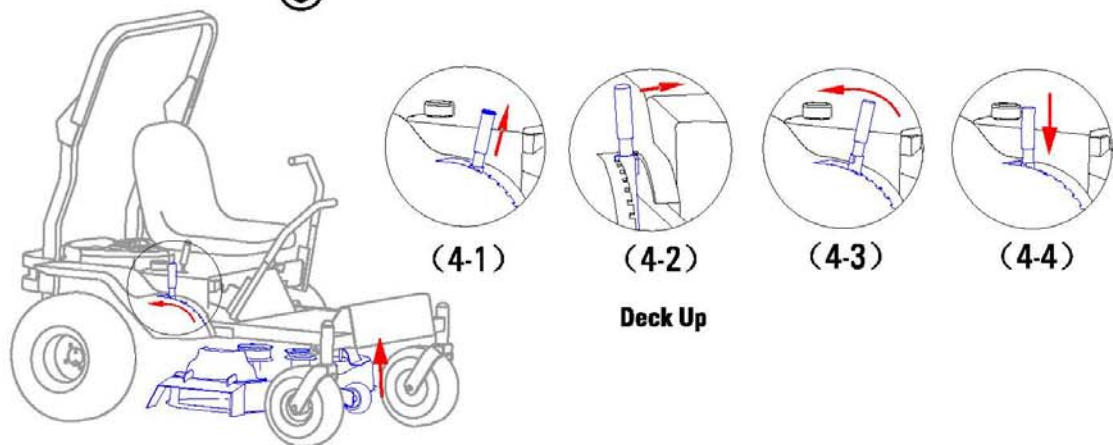

④

Deck Up

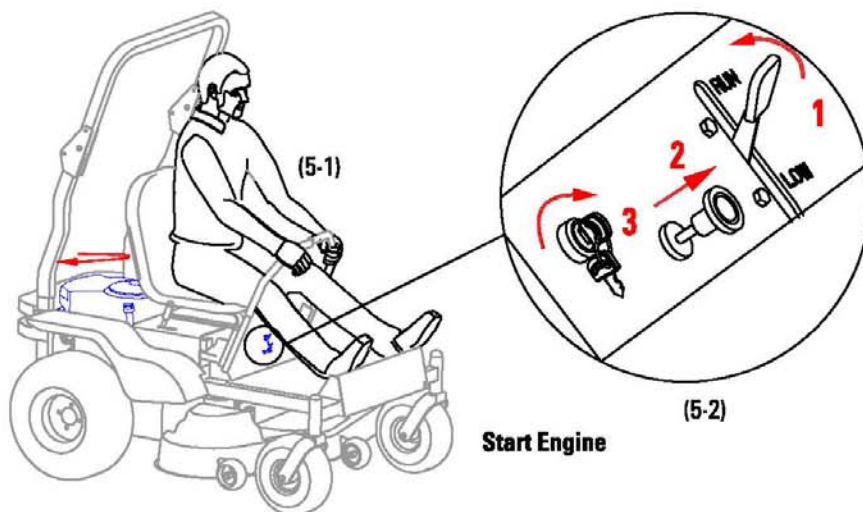

⑤

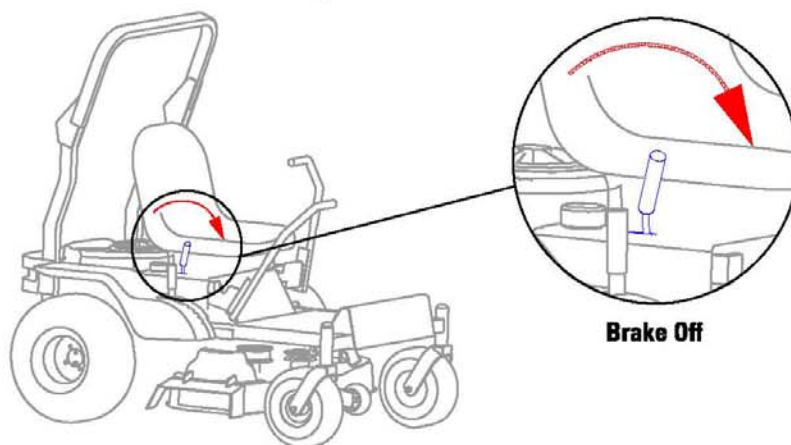

⑥

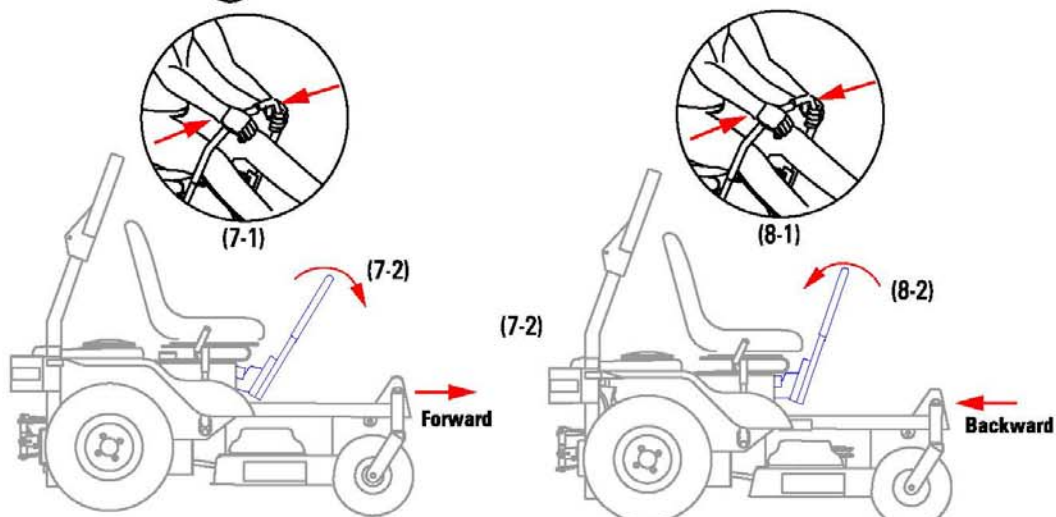

⑦

⑧

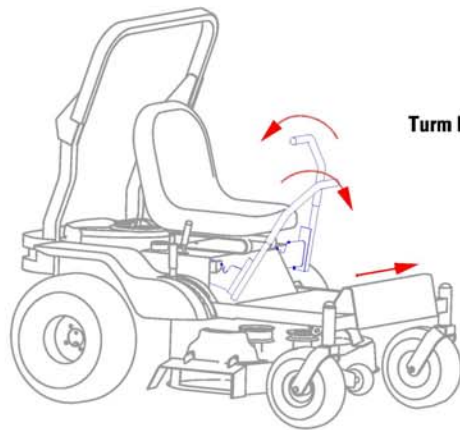

Turn Left

9

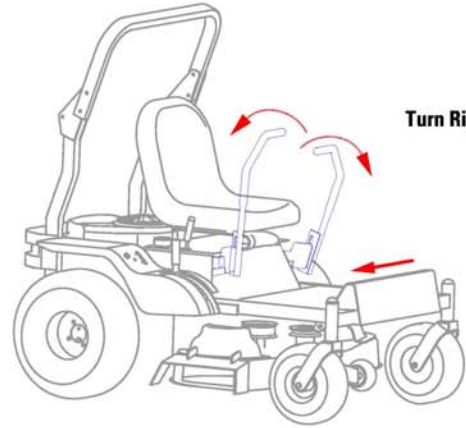

Turn Right

10

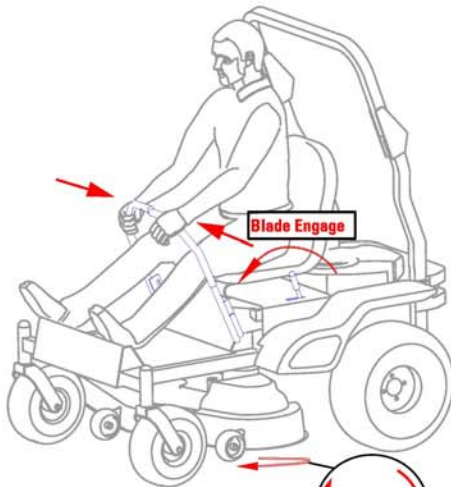

Blade Engage

11



(4-1)

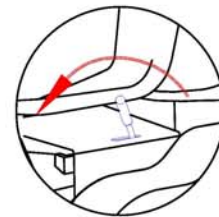

(4-2)

Blade engage

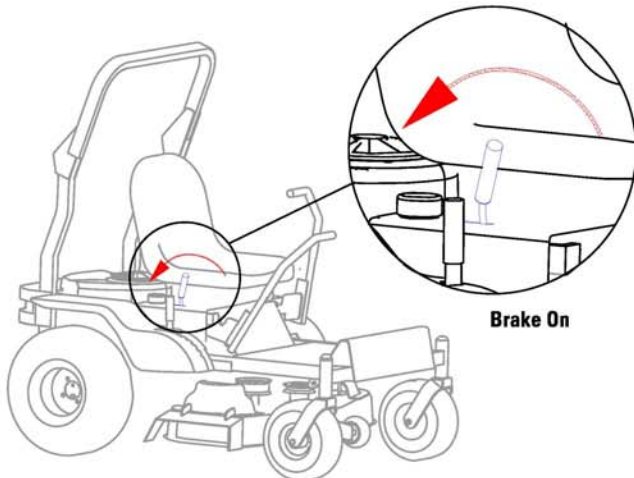

Brake On

12



**Need Help?**  
**1-919-550-3221**  
**Beastpowerequipment.com**