

# THE BEAST

100" TOW BEHIND MOWER by **DEK**

## Owner's Manual

This manual contains important safety instructions for the gasoline engine powered tow behind mower model: 100TB

READ SAFETY WARNINGS AND OPERATING INSTRUCTIONS CAREFULLY.  
SAVE THIS MANUAL.

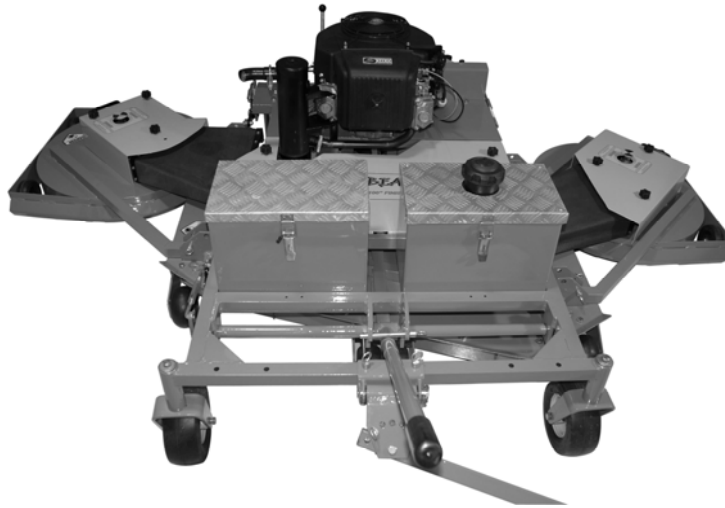

### Need Help?

Parts, Service  
and Technical Assistance call:

**1-919-550-3221**

[www.brushbeast.com](http://www.brushbeast.com)

When you call the help-line you will need to have the following information:

Date of Purchase: \_\_\_\_\_

Location of Purchase: \_\_\_\_\_

Serial # - Mower: \_\_\_\_\_

Serial # - Engine: \_\_\_\_\_

Mower and engine life are extended greatly by performing frequent lubrications, oil changes and regular maintenance. To protect your investment perform routine maintenance.

Copyright© 2009 by GXi Outdoor Power, LLC. All rights reserved.

No part of this publication can be reproduced or distributed without prior written permission of GXi Outdoor Power, LLC Clayton, NC 27520 USA.

DEK is a registered trademark of GXi Outdoor Power, LLC

GXi Outdoor Power, LLC reserves the right to discontinue or change specifications or design at any time without notice and without incurring any obligation whatsoever.

The information and specifications included in this publication were in effect at the time of approval for printing.



**This manual contains important safety instructions for Tow Behind Mowers**  
**READ SAFETY WARNINGS AND OPERATING INSTRUCTIONS CAREFULLY**  
**SAVE THESE INSTRUCTIONS.**

**This owner's manual is considered a permanent part of the tow behind mower and should remain with the mower if resold.**

## **About this Manual**

Congratulations on the purchase of your new BEAST commercial mower. We at GXi Outdoor Power are confident that this mower will provide excellent performance, outstanding quality, and great durability when operated and maintained as directed in this manual.

1. This manual contains assembly, operating, safety, adjustment, maintenance, and troubleshooting instructions. **BEFORE OPERATING YOUR LAWN MOWER, CAREFULLY READ THIS MANUAL IN ITS ENTIRETY.**
2. This owner's manual is considered a permanent part of the mower. It must be available to all operators and/or person(s) servicing the mower. Should the mower be resold, this manual must remain with the mower.
3. All information, illustrations, and specifications contained in this manual were in effect at the time of the publication. GXi Outdoor Power reserves the right to add, delete or modify specifications and/or designs without notice.
4. If you ever have questions in regards to the operation, maintenance or safety of your mower, please contact the GXi Parts & Service, LLC at 1-919-550-3221.

# **BEAST SERIES**

Check out our other great products at [www.HomeDepot.com](http://www.HomeDepot.com)  
or visit our web site at [www.brushbeast.com](http://www.brushbeast.com)



**TURF BEAST**

36-inch Walk Behind Mower



**TURF BEAST**

54-inch Walk Behind Mower



**THE BEAST**

100-inch Tow Behind Mower



**BRUSH BEAST**

36-inch Brush Mower.



**BRUSH MASTER**

Chipper/Shredder  
with 2-Way Feed

## Contents

Safety Information and Warnings.....	1
Operation Safety Precautions .....	2
Safety Decals .....	3
Product Specifications .....	4
Control Panel and Mower Components .....	5
Assembly Instructions	
Step 1: Front Wheel Assembly .....	6
Step 2: Wing Mower Assembly .....	7
Step 3: Tool Box and Fuel Tank Box .....	8
Step 4: Hitch Assembly.....	8
Step 5: Height Adjustment .....	8
Step 6: Engine Connections .....	9
Step 7: Remote Shut-Down Switch .....	9
Operating Instructions	
Starting the Engine.....	10
Stopping the Mower .....	10
Mowing in Reverse .....	10
Executing Turns with THE BEAST .....	10
Connecting THE BEAST to a Vehicle .....	11
Towing THE BEAST Offset to One Side .....	11
Wing Mower Storage and Operational Modes .....	12
Mowing with THE BEAST.....	13
Removing the Blades.....	14
Changing the Height of the Cut .....	14
Spindle Brake Inspection and Replacement .....	15
Changing from Finish Cut to Rough Cut .....	16
General Maintenance.....	17
Maintenance Schedule .....	19
Service Adjustments.....	19
Lubrication Points.....	20
Troubleshooting.....	21
Limited Warranty and Service.....	23

**Safety Information**

THE BEAST tow behind mowers are designed to give safe and dependable service if operated according to instructions. Read and understand this owner's manual before operating your mower.

**Emission Control System Information**

The U.S. and California Clean Air Acts

EPA and California regulations require all manufacturers to furnish written instructions describing the operation and maintenance of emission control systems. The following instructions and procedures must be followed in order to keep the emissions from your engine within the emission standards.

**Safety Label Locations**

Safety labels are located on your mower to warn you of potential hazards. Read them carefully. If a label comes off or becomes hard to read, contact your GXi Parts & Service, LLC for a replacement.

**Operator Responsibility**

Be sure that anyone who operates the mower receives proper instruction. Know how to stop the mower quickly in case of emergency. Understand the use of all controls and components. Children should not operate the mower without parental supervision.

**Mower Inspection**

For your safety, inspect the lawn mower before each use. Before you begin your inspection, be sure the following conditions are met: the lawn mower should be on a flat and level surface, with the ignition switch off, the key removed, and the blades disengaged. Also, disconnect the spark plug wires from the spark plugs and ground them against the engine to prevent inadvertent starting.

1. Walk around the mower and look for any fluid spills or leaks on or underneath the mower. Remove any and all excessive debris, dirt, and fluids.
2. Look for signs of damage or excessive wear. Check the tightness of all nuts, bolts, pins, and screws. Tighten any that may be loose and replace any that are missing.
3. Be sure the remote shut-down switch works correctly.
4. Check the mower blades for any damage or abnormal wear. Replace in sets so that they are balanced.
5. Check the tire pressure on all four tires. Do not exceed the recommended maximum indicated on the tire.
6. Check the belts for proper wear and correct tension. See page 19 for instructions.
7. Check engine oil and air filters as recommended in the engine manufacturer's manual.



**WARNING!** Do not use THE BEAST to carry passengers. Keep bystanders, helpers, pets and children at a safe distance from the machine while it is in operation since rotating blades can throw rocks and other items, causing serious injury. Check the area before you begin mowing for stones, sticks, wire, and other foreign objects. These objects may become projectiles when struck by the mower.



**WARNING!** Wear protective clothing while mowing. Long pants and safety glasses help reduce the risk of injury from thrown objects. Adequate footwear, such as steel toe shoes with aggressive soles, is recommended to help protect your feet and maintain traction on slopes or uneven grounds. Always wear hearing protection.



**DANGER! GASOLINE IS HIGHLY FLAMMABLE AND EXPLOSIVE.** Do not add fuel while the engine is running or is hot. Keep open flames, sparks, and heat away from the fuel and store fuel in containers specifically designed for that purpose. **ADD FUEL OUTDOORS ONLY AND IF THE FUEL IS SPILLED, DO NOT START THE ENGINE.** Manually push the mower away from the spill and wipe up immediately.

**Equipment Operation—Safety Precautions**

1. Do not operate the engine in a confined space where dangerous carbon monoxide fumes can collect. Carbon monoxide is odorless, tasteless, and can be fatal.
2. Mow only in daylight.
3. Make sure the mower is parked on a level surface. The mower should either be connected to a towing vehicle or the wheels should be chocked. Make certain the blades are disengaged before attempting to start the engine.
4. Be extremely careful when operating the mower on a slope or when the grass is damp or wet. Reduced traction could cause sliding. Never mow close to ditches as the implement could slip dragging the towing vehicle and operator in with it.
5. Do not stop or start suddenly when going uphill. Use extreme caution when changing directions while operating on a slope.
6. Avoid steep slopes.
7. Watch for pedestrian or vehicular traffic when moving the mower while not in use (i.e., loading, unloading or transporting).
8. Never operate the mower with defective guards or shields, or without the safety devices securely mounted in place.
9. Never direct discharge of material toward bystanders nor allow anyone near the mower during operation.
10. Do not change the governor settings or over speed the engine.
11. Always stop the engine when you leave the towing vehicle, even for a moment.
12. To help reduce the fire hazard, keep the engine and the area around the engine free of grass, leaves or any other type of foreign material.
13. Beware of cutting edges. Always wear gloves for safety when performing blade maintenance activities. Beware of multiple blade units since the rotation of one blade may cause the rotation of the other blade(s).
14. Do not operate without blade baffles or guards in place.

**GASOLINE IS HIGHLY FLAMMABLE AND EXPLOSIVE. FUEL LEAKS, A LOOSE FUEL TANK, OR A LOOSE FUEL VALVE CAN LEAD TO SEVERE INJURY OR DEATH. DO NOT OPERATE THIS MOWER IF ANY COMPONENT OF THE FUEL SYSTEM IS LOOSE OR LEAKS GASOLINE!**

**IMPORTANT!** The mower belts are adjusted to ensure the blades stop turning within seven (7) seconds of releasing the blade control lever. If you are making any belt adjustments whatsoever, for your safety and the safety of others around you, you must ensure the belts are re-adjusted to achieve this design specification. When wing mowers are in use, blades may not stop in 7 seconds. Visual indication that the blades are turning is provided on both wing mowers. Do not approach the mower or attempt any service until the after the visual warning disks have completely stopped turning. Slow moving blades can cause serious injury or death.

Before setting up your brush mower, disconnect the spark plug wires from the spark plugs and ground them against the engine to prevent inadvertent starting. This step should be taken as a precaution whenever you are working on this machine.

**DANGER!** Do not bypass, modify, alter or disconnect the safety system. Make sure that the safety interlock system is fully operational each time before mowing.

Before attempting to use your mower, make sure you are familiar with all of the components and have read the manual.

**Need Help?**

Parts, Service  
and Technical Assistance call:

**1-919-550-3221**

[www.brushbeast.com](http://www.brushbeast.com)

**Safety Decal Identification**

The labels shown below are located on your mower to warn you of potential hazards and provide you with important safety information. If these decals become difficult to read or are missing from the mower, please contact GXi Parts & Service, LLC at 1-919-550-3221 or [www.brushbeast.com](http://www.brushbeast.com) for a replacement.

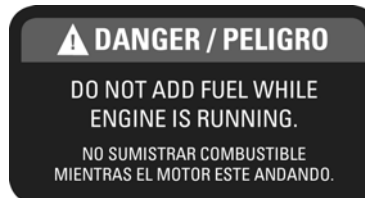
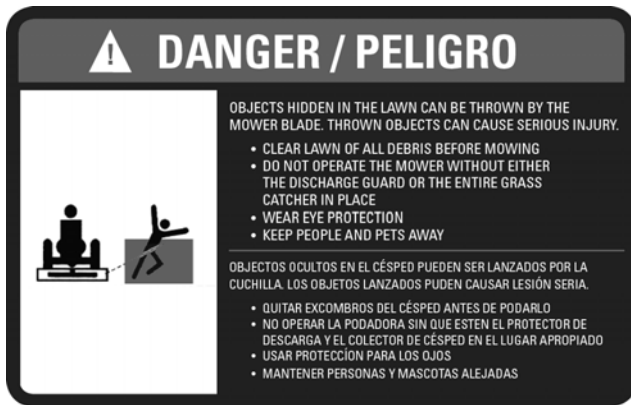
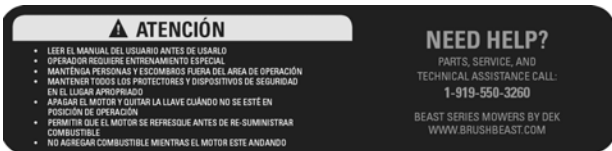
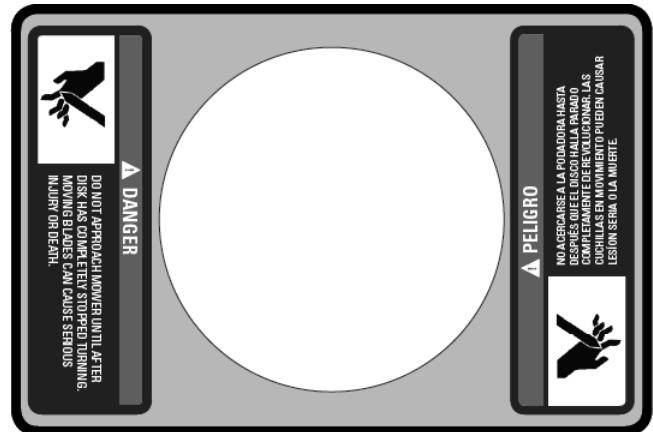

	<b>Model</b>
<b>Feature</b>	<b>100TB</b>
Product Type	Tow behind
Cutting Width	100-inch finish, 52-inch rough
Engine	See engine manufacturer’s engine manual
Engine Start	Electric
Deck Type	Floating, quick change
Cutting Height	1.5-4.5 inches( ½-inch increments)
Blade Engagement	Manual clutch
Blade Tip Speed	18,750 ft/min
Anti-Scalping Rollers	10
No. Blades/ Length	4, 26-inch blades
Fuel/Capacity	Gasoline/4.5 gals.
Rear Drive Tires	13-inch x 6.5-inch turf tread
Front Caster Tires	9-inch x 3.5-inch smooth tread
Weight	Approx. 450 lbs.
Height/Length	48 inches x 78 inches

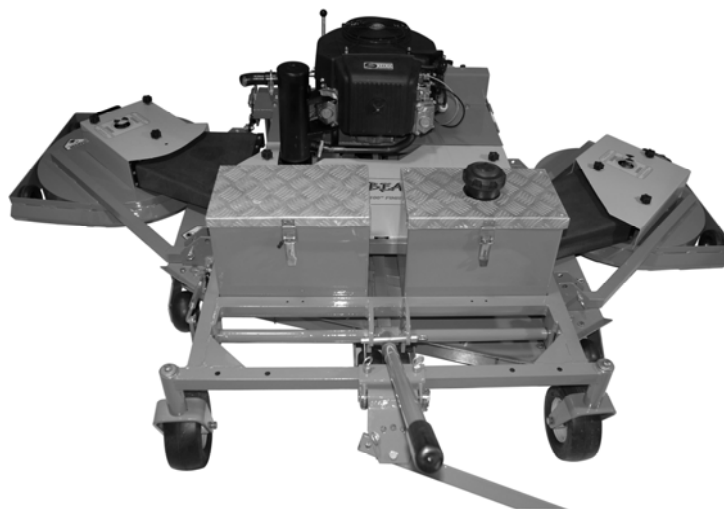



Throughout this manual, instructions are given on the operation of your TURF BEAST mower. We recommend that while going through this manual, you have your mower available for quick and easy access in order to orient yourself with the controls, maintenance and orientation of different parts. Please read through the manual before operating.

**Control Panel**

Below, you will find a diagram of the control panel. Please take the time to familiarize yourself with the mower controls.

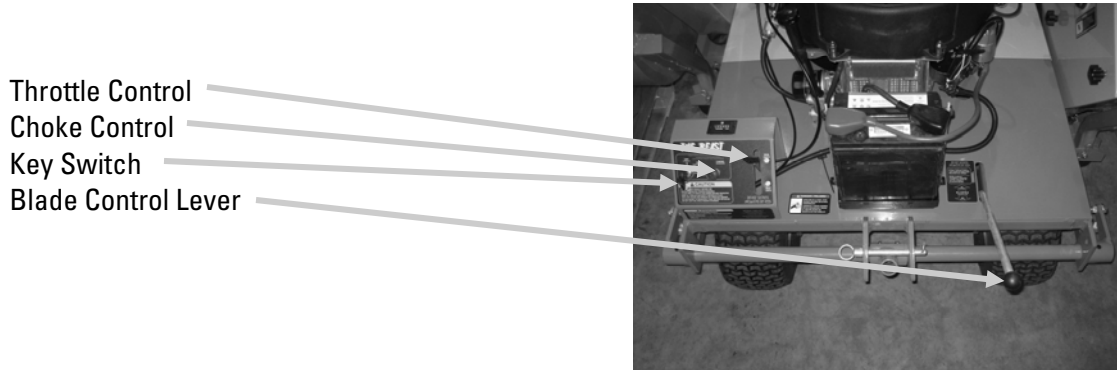

**Mower Component Identification**

(Some components may appear different than shown, depending on the model.)

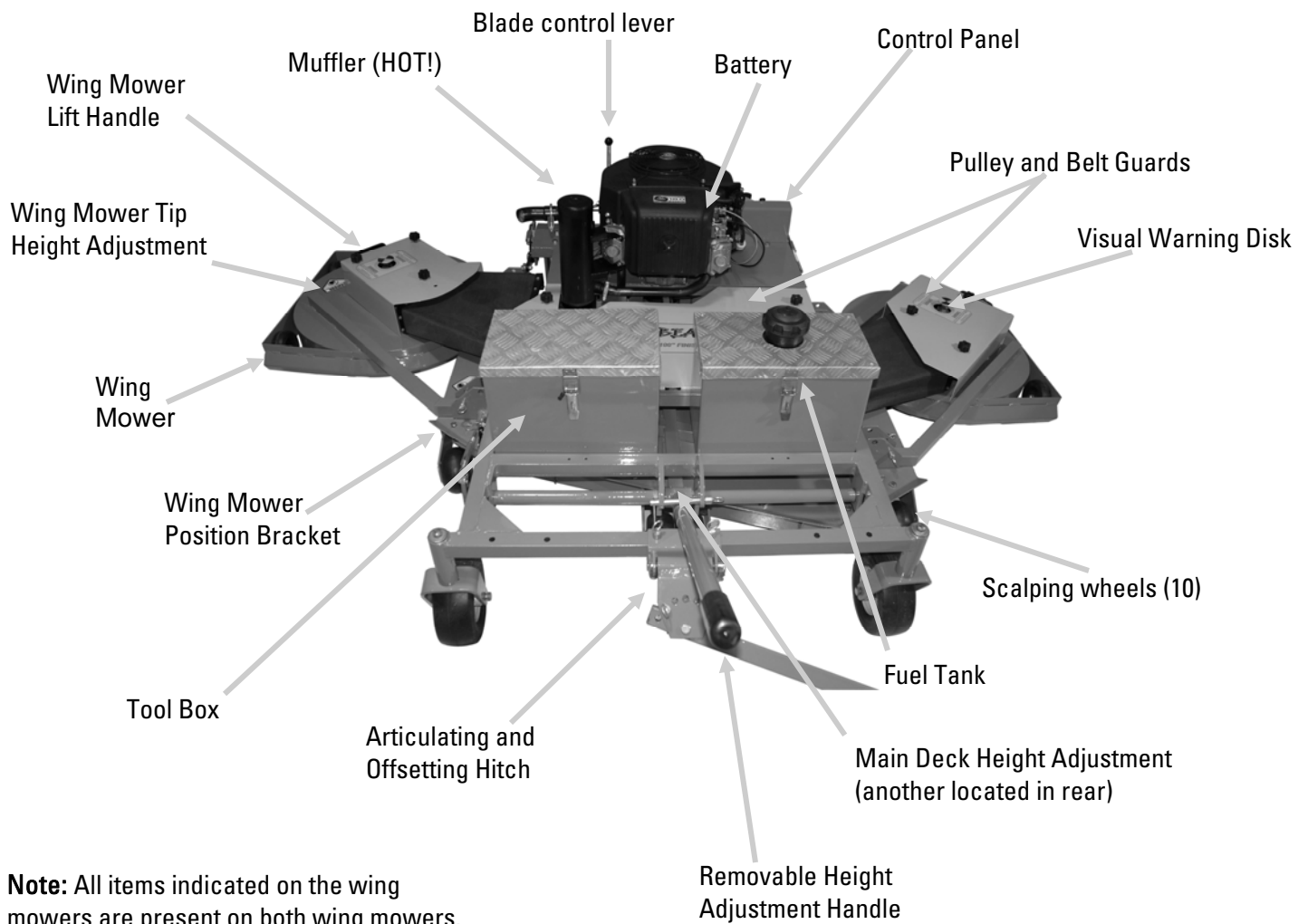

**Note:** All items indicated on the wing mowers are present on both wing mowers.

**Step 1: Front Wheel Assembly**

**Note:** Some mowers may be shipped with the front wheels pre-assembled.

- A. Remove packaging materials surrounding the front wheels and remove the bolt threaded into the front wheel. Retain this bolt and washer for future use.



- B. Unscrew the fastener holding the bolt to the steel shipping rack. Set the nut and bolt aside.



- C. While still in the shipping rack, lift the front of the mower and support it on jack stands.

- D. Slide the front wheel pivot shaft through the sleeve. If the fit is tight, apply some grease to the pivot shaft.



- E. Secure the shaft in place with the bolt and hardware that were provided with the wheel.

- F. Apply grease to the front wheel sleeve grease fittings when complete.

- G. Repeat steps A through F for the second front wheel.

- H. Remove the two (2) bolts attaching the shipping rack to the rear of mower. Tap the bolts if necessary to remove them. Lift the rear of the mower from shipping rack.



- I. Remove the shipping rack from the front of the mower.

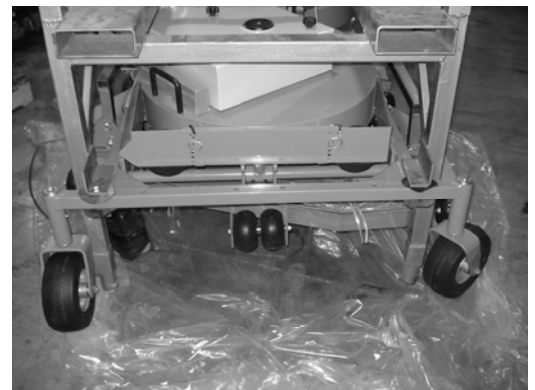

**Step 2: Wing Mower Assembly**

Some mowers may be shipped with the wings pre-assembled. If the wing mowers are pre-assembled, go to step 3.

**Note:** Some tasks require more than one person.

A. Remove the nut from the two wing shipping bolts.



B. With the help of another person lift the wing closest to the end of the shipping bolts where you removed the nut. Shift the wing off the end of the bolt and place it on the side where it will be mounted.

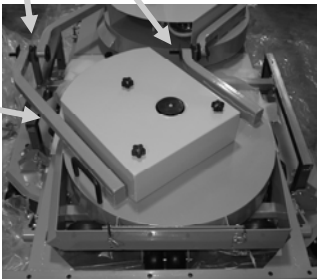

C. Supporting the other wing, remove the shipping bolts. Lift the wing and place it on the side where it will be mounted.



D. Remove the three (3) pins on each side of the wing mower section of the shipping rack and remove the rack section. Retain the pins for later use.

E. With the help of another person align the wing pivot with the wing pivot bracket hole. Insert the pins removed from the shipping rack through the wing pivot bracket and the wing pivot at the front and back of the wing. **Note:** If the pins do not insert easily, apply a thin film of grease or oil and tap the pins in with a hammer. **DO NOT DRIVE THE PINS IN HARD WITH A HAMMER.**

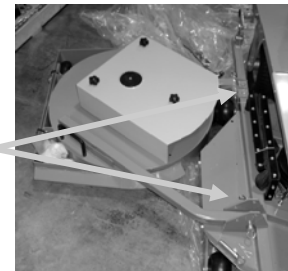

F. Loosen the knobs and remove the blade pulley guard.

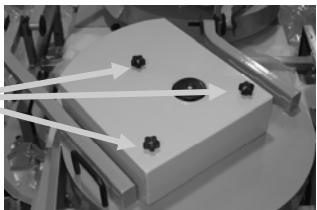

G. Using the handle, hold the wing steady, remove the wing locating pin, and insert the pin into the operating position hole. Slowly lower the wing until it rests on the locating pin at approximately a 35° angle.

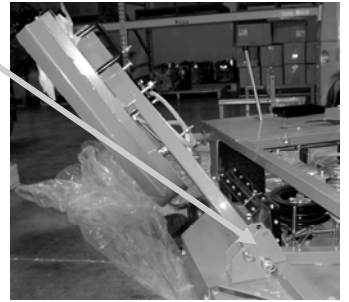

H. Wrap the supplied belt around the wing mower blade pulley and the wing tension pulley. Insert the belt under the loose flexible guarding and wrap the belt around the double pulley on the main deck. The belt goes in the lower groove of all pulleys. **Note:** The wing belt tension pulley pushes outward on the belt, so the inside of the belt will seat in the pulley.

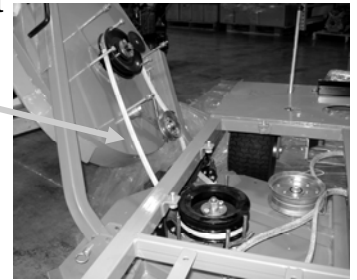

I. Install the flexible guarding bracket. **Note:** The bracket may be wrapped up in the flexible guarding material, and you may have to stretch the material to install.

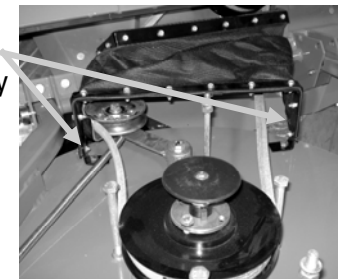

J. Raise the wing mower back to the stored position, and remove the locating pin. Lower the wing mower all the way down, and reinsert the wing locating pin to keep the wing in the proper position during operation.

K. Secure the wing mower blade pulley guard in place with the knobs.

L. Repeat this process for the other wing mower.

M. Install the main deck belt in the top groove.

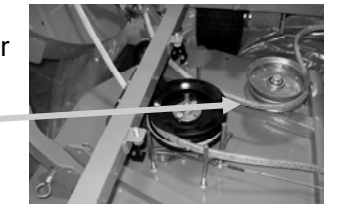

Never under any circumstances, approach or lift the wing mowers while the engine is running. Always wait until after the visual indicator has stopped completely before performing any service or adjustments to the wings.

**Step 3: Tool Box and Fuel Tank Box**

- A. Open the tool box and the fuel tank box. Place the boxes on the frame aligning the four holes for mounting each box.

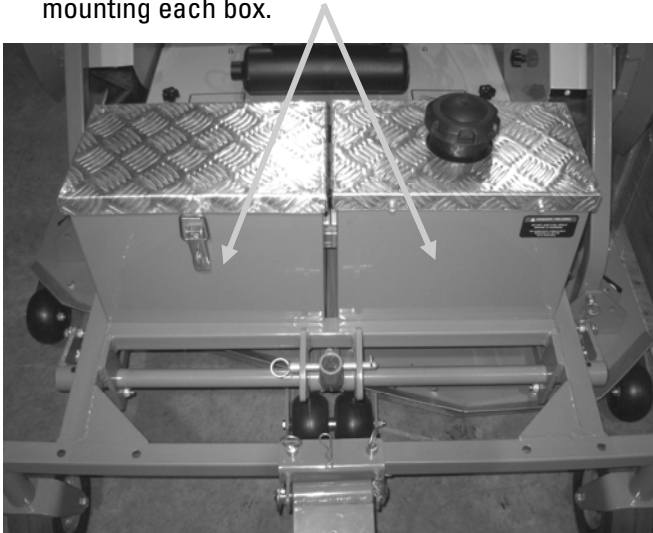

- B. Once the boxes are mounted, close the lid on the toolbox, and place the fuel tank in the fuel tank box.
- C. Secure the fuel tank box lid, insert the fuel valve, and connect the supplied fuel line.



**DANGER! GASOLINE IS HIGHLY FLAMMABLE AND EXPLOSIVE.** FUEL LEAKS, A LOOSE FUEL TANK, OR A LOOSE FUEL VALVE CAN LEAD TO SEVERE INJURY OR DEATH. ENSURE ALL CONNECTIONS ARE SECURE AND INSPECT THOROUGHLY FOR ANY POTENTIAL LEAKS IN THE FUEL SYSTEM. IF YOU FIND A LOOSE CONNECTION OR A LEAK, MAKE AN IMMEDIATE REPAIR OR ASK FOR ASSISTANCE FROM A PROFESSIONAL MECHANIC OR SERVICE CENTER.

**DO NOT OPERATE THIS LAWN MOWER IF ANY COMPONENT OF THE FUEL SYSTEM IS LOOSE OR LEAKS GASOLINE!**

**Step 4: Hitch Assembly**

The hitch is shipped essentially preassembled.

- A. Remove the retaining clip and pin from the channel-shaped end that allows the hitch to pivot up and down.
- B. Slide the channel shaped end over the tube between the front wheels.
- C. Use the pins removed in Step A to fasten the hitch to the mower.

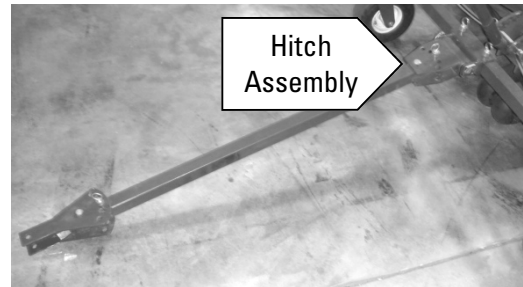

**Step 5: Height Adjustment**

THE BEAST is equipped with an easily-adjustable floating deck, which can be adjusted for cut heights of 1½ inches to 4½ inches in ½-inch increments.

- A. Place the height adjustment handle into either the front or rear height adjustment sockets.
- B. Remove the retaining clip and pin from the height adjust bracket. Press down on the height adjustment handle until the hole in the height adjust bar aligns with the desired cut height hole on the height adjust bracket.
- C. Replace the retaining clip and pin in the height adjust bracket. Release pressure on the handle.
- D. Repeat the same adjustment process on the opposite end of the mower.

**Note:** For a level cut, adjust the cut height on the wings to match the mower for level cut height.

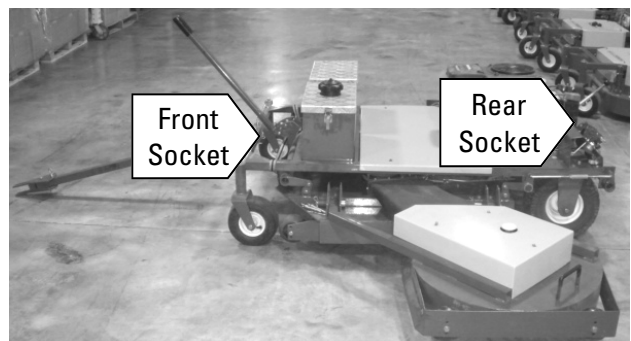

**Step 6: Engine Connections**

1. Check the wiring harness connections to make certain all connections are secure from the key switch to the engine plug.

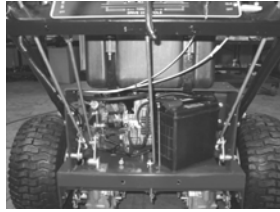

2. Route the smaller, white, 2-pin connector through a hole in the chassis and connect it to the blade activation safety switch 2-pin connector.



3. Connect the larger, 5-pin connector to the mating connector at the rear of the engine.



4. Connect the black wire to a ground lug located on the back or side of the engine.



5. If equipped, attach the yellow wire to the bottom of the starter motor solenoid on the engine, with the positive (red) battery cable.

Attach the positive (red) and ground (black) battery terminal wires to the battery to provide power to the electric starter. **Note:** Battery ground should be to the engine block.

6. Verify that the throttle and choke connections allow full travel of both levers on the control panel. If adjustments are needed, see connection instructions in the Engine Owner's Manual.

7. Inspect ALL fuel lines and fuel line connections from the tank to the engine.



**Step 7: Remote Shut-Down Switch**

The most important safety system on a tow behind mower is the operator. THE BEAST is equipped with a remote shut-down switch. Connect this switch harness to THE BEAST under the control panel. Use the provided wire ties to secure the switch within easy reach of the towing vehicle operator during mower operation. The operator is responsible to be aware of the surroundings, focus on safe operation of the mower and be prepared to shut the engine down immediately, if necessary.



Use the remote shut-down switch to stop the blades if any emergency situation or serious operating issue arises. The following are examples of occurrences when the shut-down switch should be used:

- Any unusual noise or excessive vibration coming from THE BEAST. Unexpected noise or vibration are usually a sign of an oncoming problem.
- Any person, child, animal, or personal property is in the mowing area.
- The mower begins to slide down a slope or into a ditch.
- The mower becomes jack-knifed during towing.
- There is a loss of braking power on the towing vehicle.
- The towing vehicle or THE BEAST becomes stuck in mud or any other obstacle.
- If any part of THE BEAST becomes entangled in any type of obstacle.

If there is a situation you are uncertain is safe, DO NOT attempt operating THE BEAST in the area.

ALWAYS inspect the area to be mowed for any stones, sticks, wire, and other foreign objects. These objects may become projectiles that can cause serious injury and/or death when struck by the mower.

**GASOLINE IS HIGHLY FLAMMABLE AND EXPLOSIVE. FUEL LEAKS, A LOOSE FUEL TANK, OR A LOOSE FUEL VALVE CAN LEAD TO SEVERE INJURY OR DEATH. DO NOT OPERATE THIS MOWER IF ANY COMPONENT OF THE FUEL SYSTEM IS LOOSE OR LEAKS GASOLINE!**

Before attempting to use THE BEAST, make sure you are familiar with all of the components and have read the manual.

### Starting the Engine



**DANGER!** Exhaust contains poisonous carbon monoxide, a colorless and odorless gas. Breathing exhaust can cause loss of consciousness and may lead to death. Do not operate the engine in a confined space where dangerous carbon monoxide fumes can collect.

NOTE: Be sure to add fresh unleaded gasoline and fill the engine with manufacturers recommended motor oil before starting your mower.

1. Make sure the shut off valve, located at the bottom of the tank, is in the ON position.
2. Make sure the blade control lever is in the OFF position. NOTE: The safety interlock system prevents the engine from being started if the blade control lever is not in the OFF position.
3. Pull CHOKE if necessary.
4. Turn the key clockwise to the START position and allow it to return to the ON position when the engine starts.
5. When the engine starts to run and the key returns to the ON position, push CHOKE off.

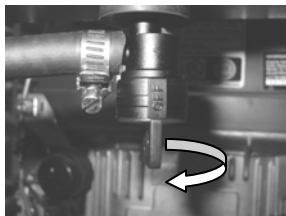

### Stopping the Mower

To stop THE BEAST, turn the remote toggle switch to the OFF position or turn the mower off at the main control panel on the back corner of the chassis. Make certain the blades are turned to the OFF position before attempting the restart. **Note:** The key must be in the OFF position, even if the remote shut-down switch is on OFF, to prevent drain on the battery.

Braking distances for the towing vehicle will be increased because of the weight of the Tow Behind Mower. Use caution until you are comfortable with the abilities of the towing vehicle to stop the mower.

### Mowing in Reverse

1. ALWAYS watch where you are going, and make certain the area is clear before backing up.
2. Back up slowly and carefully. Do not allow THE BEAST to jackknife.
3. If the hitch is in an offset configuration, use EXTREME CAUTION in reverse to prevent jackknifing.

NEVER BACK THE MOWER TOWARDS DITCHES OR OVER RIDGES ONTO SLOPES. THE WEIGHT OF THE MOWER CAN PULL YOU AND YOUR TOWING VEHICLE INTO A DITCH OR DOWN A HILL CAUSING SERIOUS INJURY OR DEATH.

### Executing Turns with THE BEAST

1. ALWAYS reduce speed to make turns of any kind.
2. The turning radius of THE BEAST is limited by the design of the towing vehicle. The hitch can come into contact with the towing vehicle during turns, and the radius of the turn must be limited to prevent this contact.
3. Use EXTREME CAUTION when executing turns on hills and slopes.
4. Tow behind models equipped with wing mowers can potentially execute a zero turn about the tip of one of the wings. Use EXTREME CAUTION due to the potential to jack-knife THE BEAST.

**Connecting THE BEAST to a Vehicle**

1. Refer to the vehicle owner’s manual for recommendations and proper connections to the vehicle used to tow the mower. Make certain the vehicle can handle towing attachments. **Note:** Some vehicles require a strengthened draw bar to tow THE BEAST.

2. Back the vehicle straight in line with the mower hitch. **Note:** You may pull the offset selection pin at the connecting point to gain some flexibility while connecting the mower, but that pin must be returned before towing the mower.



3. Place the vehicle in park, remove the wheel chocks, and follow the remaining procedures for mowing grass.

**NEVER STOP THE MOWER ON SLOPES OR INCLINES. THE WEIGHT OF THE MOWER CAN PULL THE VEHICLE WITH IT DOWN HILLS OR RAMPS.**

ONLY CONNECT THE MOWER ON A LEVEL SURFACE WITH THE MOWER WHEELS CHOCKED. NEVER DISCONNECT THE TOW BEHIND MOWER ON A SLOPE OF ANY GRADE, AND ALWAYS CHOCK THE WHEELS WHEN THE MOWER IS NOT CONNECTED TO A VEHICLE.

**Towing THE BEAST Offset to One Side**

THE BEAST has three (3) hitch connecting positions on the frame of the mower so the mower can be pulled offset to either side of the towing vehicle. In any of these three (3) connecting positions, the mower offset can be increased using the offset hitch.

If the towing vehicle is a lawn mower, the offset allows the lawn mower and THE BEAST to engage uncut grass, greatly increasing the total cutting width. **Offset THE BEAST to the side opposite the discharge chute of the lawn mower so the discharged grass from the lawn mower does not overload THE BEAST.** If the lawn mower is in a mulching configuration, THE BEAST can be offset to either side.

1. Pull the offset selection pin from the hitch connection end closest to THE BEAST. Swing the hitch in the opposite direction of the desired offset, and insert the pin in the hole for the desired offset angle.



2. Pull the offset selection pin from the hitch closest to the vehicle connection end. Rotate the hitch to the hole corresponding the angle used in Step 1, and return the pin.

3. For more offset, remove the two hitch retaining pins, shift the hitch assembly to the hitch connecting position on either side of THE BEAST frame and reinsert the pins.

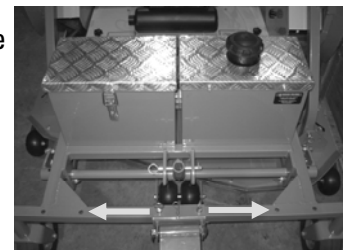

4. If even more offset is necessary, fasten the offset extension tube to the frame of THE BEAST so it overhangs away from the main deck. Attach the hitch to the connection holes in the offset extension tube.



**WARNING! NEVER OFFSET THE MOWER TOWARD A DITCH OR SLOPE. THE WEIGHT OF THE MOWER CAN SLIDE AND PULL THE TOWING VEHICLE AND OPERATOR INTO THE DITCH CAUSING SERIOUS INJURY OR DEATH.**

**Wing Mower Storage and Operational Modes**



**WARNING!** NEVER APPROACH, SERVICE, OR ATTEMPT TO MOVE THE WING MOWERS WITH THE ENGINE RUNNING. ALWAYS MAKE CERTAIN THAT ALL BLADES ARE STOPPED ON THE WINGS BY OBSERVING THE VISUAL WARNING DISK.

**IMPORTANT!** Always use the handle to raise or lower the wing mowers to prevent potential injury or damage.

**Storage to Operational Mode**

1. Be sure THE BEAST is parked on a level surface, the engine is off and no blades are turning. Remove spark plug wires from spark plugs.



2. Pull the retaining spring pin, hold the wing mower steady using the handle, and pull the wing mower locating pin.



3. Using the handle, slowly lower the wing mower to the operating position. Replace the wing mower locating pin in the operation position and return the retaining pin.

4. Repeat this process on the other wing mower, and set the wing cut heights to match the main deck cut height.

**Operational to Storage Mode**

1. Be sure THE BEAST is parked on a level surface, the engine is off and no blades are turning. Remove spark plug wires from spark plugs.

2. Remove the retaining spring pin and the wing mower locating pin.



3. Lift the wing mower to the stored position using the supplied handle. Hold the wing mower steady and return the wing mower locating pin to the stored position and return the retaining spring pin.



**DO NOT ALLOW WINGS TO HANG OVER INTO DITCHES. WINGS CAN BE TANGLED BY UNSEEN OBSTACLES AND DRAG THE VEHICLE AND OPERATOR INTO DANGER.**

**IMPORTANT!** The mower belts are adjusted to ensure the blades stop turning within seven (7) seconds of releasing the blade control lever. When wing mowers are in use, the blades may not stop in seven (7) seconds. Visual warning disks on both of the wing mowers indicate whether the blades are turning. Do not approach the mower or attempt any service until after the visual warning disks have completely stopped turning.



**Mowing with THE BEAST**



**WARNING!** Thoroughly inspect the area where you plan to use the mower. Look for items such as stones, sticks, wire, and other foreign objects. If struck by the mower, these and other objects may become projectiles that could lead to serious injury or death. Clear area of all debris. Keep people and pets at a safe distance.



**WARNING!** Do not operate the mower with defective guards, shields, or without the safety devices securely in place.

1. When the mower is in position on the area to be mowed, start the engine and bring the engine to operating speed.
2. With the other hand, **SLOWLY** push the blade control lever forward to the ON position pausing for 10-15 seconds in the soft start range.



**The Soft Start feature is critical to maintaining belt, clutch, and engine life. NEVER "slam" the blade on/off handle from off to on without pausing an adequate time in the soft start range.**

3. Walk back to the towing vehicle keeping clear of the mower decks by at least three feet.
4. Slowly begin pulling the tow behind mower with the vehicle. Speed can be increased as long as cut quality is maintained and there is no engine rpm reduction or belt slip. This is dependent on the height, condition and type of grass. NOTE: The pulley and blade system is designed so the belts slip before damage to the engine can occur.
5. To stop the blades, pull the blade control lever back to the OFF position.



**WARNING!** The blades may take up to seven (7) seconds to stop turning OR more with the wing mowers down. Observe the visual warning disks on the wing mowers to indicate turning blades.

**WHEN WING MOWERS ARE IN USE, THE BLADES MAY NOT STOP IN 7 SECONDS. VISUAL INDICATION THAT THE BLADES ARE TURNING IS PROVIDED ON BOTH WING MOWERS. Do not approach the mower or attempt any service until the after the visual warning disks have completely stopped turning. Slow moving blades can cause serious injury or death.**

**IMPORTANT!** The mower belts are adjusted to ensure the blades stop turning within seven (7) seconds of releasing the blade control lever. If you are making any belt adjustments whatsoever, for your safety and the safety of others around you, you must ensure the belts are re-adjusted to achieve this design specification.

## Removing the Blades

**Required tools:** Two (2) 15/16" box end wrenches



**CAUTION!** Beware of the cutting edges on the blades. The rotation of one blade may cause the other blade(s) to rotate. Always wear work gloves when handling blades.

### Main Deck Blade Removal

1. Park the mower on level ground and block the rear wheels to prevent accidental rollback.
2. Raise the deck cutting height to 4.5 inches to provide as much clearance as possible for the blade removal.
3. Remove the covers and guards from the main deck.
4. Raise the front end of the mower using a jack and secure at least two jack stands to hold the mower up.
5. Use one wrench to loosen nut A while holding bolt B with the other wrench.

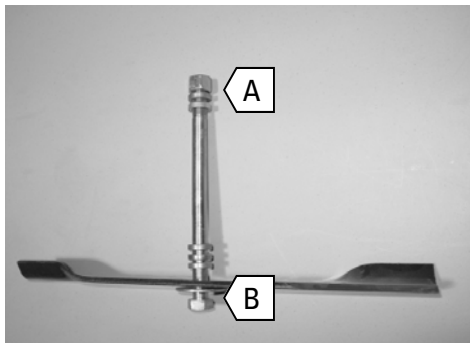

6. Retain spacers and remember or record where the spacer should be placed during installation.
7. Slide the blade bolt down through the mower deck and out.
8. To reinstall, reinsert the blade bolt through the cutting deck.
9. Reinstall the blade spacers onto the blade bolt followed by the nut and tighten.

**IMPORTANT:** Use an equal number of spacers on each blade bolt. NEVER put the spacers below the blade.

### Wing Mower Deck Blade Removal (for equipped models)

1. Park the mower and level ground and block the rear wheels to prevent accidental rollback.
2. Raise the deck cutting height to 4.5" to provide as much clearance as possible for the blade removal.
3. Remove the covers and guards from the wing mower.
4. Raise and secure the wing mower into storage mode.
5. Remove the visual warning disk by removing the countersink bolt.
6. Use one wrench to loosen nut A while holding bolt B with the other wrench. (See photo in Main Deck Blade Removal.)
7. Retain spacers and remember or record where the spacer should be placed during installation.
8. Slide the blade bolt out through the mower deck spindle.
9. Reinstall the blade spacers onto the blade bolt followed by the nut and tighten.

**IMPORTANT:** Use an equal number of spacers on each blade bolt. NEVER put the spacers below the blade.

### Changing the Height of Cut

THE BEAST is equipped with a floating deck that can be adjusted for cut heights of 1.5 inches to 4.5 inches in ½-inch increments. There are two lift points (one in the front and one in the rear). A height adjustment handle is provided and is stored in either of the lift point sockets.

1. Place the height adjustment handle into either the front or rear height adjustment sockets.
2. Remove the retaining clip and pin from the height adjust bracket. Press down on the height adjustment handle until the hole in the height adjust bar aligns with the desired cut height hole on the height adjust bracket.
3. Replace the retaining clip and pin in the height adjust bracket. All four (4) height adjust pins must be set to the same cut height position. Release pressure on the handle.
4. Repeat the same adjustment process on the opposite end of the mower.

**Note:** If your mower is equipped with wings, adjust the cut height on the wings to match the mower for smooth cut height.

## Spindle Brake Inspection and Replacement

**IMPORTANT!** The mower belts are adjusted to ensure the blades stop turning within seven (7) seconds of releasing the blade control lever. If you are making any belt adjustments whatsoever, for your safety and the safety of others around you, you must ensure the belts are re-adjusted to achieve this design specification.

When wing mowers are in use, blades may not stop in 7 seconds. Visual warning disks on both of the wing mowers indicate whether the blades are turning. Do not approach the mower or attempt any service until after the visual warning disks have completely stopped turning.

**Blade and pulley brake inspections should be performed every 50 blade on and off cycles.**

Before beginning service, park THE BEAST on a flat and level surface, with the ignition switch off, the key removed, and the blades disengaged. Also, disconnect the spark plug wires from the spark plugs and ground them against the engine to prevent inadvertent starting.

1. Engage the blade handle (make certain the engine cannot start) to pull the brakes off of the pulleys.
2. Remove the pulley guard from the main deck.  
**Note:** The wings will need to be in the operational mode in order to remove the guard and observe the brakes.
3. Visually inspect the brake pads for wear. Make certain that no metal has been touching the pulleys.
4. The brake pad material should be approximately 1/8-inch thick. Replace the brakes if the material is less than 1/16-inch thick. **Note:** Replacing both brakes is recommended if replacement of one brake is required.
5. To replace the brake, use a pair of pliers to remove the springs.
6. Remove the two mounting bolts and disconnect the spring from the cable.

7. Discard all of these parts. DO NOT reuse springs. New brakes are equipped with new springs for proper braking.
8. Install the new brakes by reversing the procedure in steps 5 and 6.
9. Disengage the blade handle and inspect the brake contact surface. All of the brake pad contacting material should be contacting the bottom of the pulley.

**Note:** Springs may vary from those pictured based on the particular application.

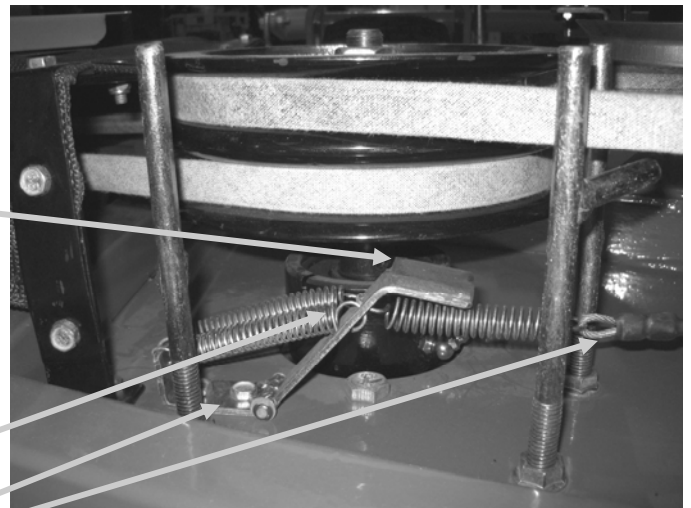

**Changing from Finish Cut to Rough Cut**

**THE ROUGH CUT CONFIGURATION SHOULD ONLY BE OPERATED IN THE 4 INCH OR 4.5 INCH CUT HEIGHT SETTINGS. A LOWER HEIGHT SETTING COULD RESULT IN DAMAGE TO THE BELTS OR OTHER PARTS OF THE MOWER INCLUDING THE ENGINE.**

Before beginning service, park THE BEAST on a level surface, turn the blades off, turn the engine off, take the key out of the switch, wait an adequate time to make certain no blades are turning, and remove spark plug wires from spark plugs. Be sure to chock the wheels to prevent accidental rolling.

1. Remove the main deck guard. Lower the wings into the operational mode to provide clearance (for equipped models).
2. Raise the deck to the highest height setting of 4.5 inches.
3. Remove the bolts holding the blade baffles on. Retain these bolts for later use.
4. Using a jack, raise the front of the mower, and secure the front with jack-stands.
5. Pull the blade baffles out from underneath the mower.



- Return the bolts to the blade baffles for storage.
6. Remove the blades following the proper procedure outlined on Page 14, and install the flat rough cut blades.
  7. Using a jack, remove the jack-stands, and lower the mower to the ground.
  8. Raise the wings into storage mode.
- Note:** Wing mowers cannot be used in rough cut mode.

**NEVER USE THE WING MOWERS IN THE ROUGH CUT CONFIGURATION. DOING SO WILL DAMAGE THE WING MOWERS AND BELTS. THE WING MOWERS ARE FOR USE ONLY IN FINISH CUTTING OPERATIONS.**

9. Remove the stored bolts from the rough cut guarding. Position the rough cut rubber guarding on the front and rear of the mower.



10. Align the holes and insert the bolts to secure the guarding. **DO NOT** tighten the bolts until all of the bolts have been started.
11. Fasten the guarding securely, and inspect your mower carefully. **MAKE CERTAIN ALL TOOLS ARE REMOVED FROM THE MOWER.**
12. Following the safe operation procedures outlined on page 10, start the engine, then start and stop the blades two or three time before beginning to mow. **ONLY START THE MOWER IN A SAFE, VENTALATED AREA, AWAY FROM BYSTANDERS.** If there are any unusual noises, inspect the mower for secure connections before beginning to mow.
13. Follow safe mower operating procedures to cut in the rough cut setting. **ONLY OPERATE IN THE 4 OR 4.5 INCH CUT HEIGHTS.**

**Changing from Rough Cut to Finish Cut**

Reverse the previous procedure and reinstall the mulching blades. For equipped models the wing mowers are ready for use. **IF GRASS IS HEAVY OR WET DO NOT USE THE WING MOWERS.**

**IMPORTANT!** The mower belts are adjusted to ensure the blades stop turning within seven (7) seconds of releasing the blade control lever. If you are making any belt adjustments whatsoever, for your safety and the safety of others around you, you must ensure the belts are re-adjusted to achieve this design specification.

**The Importance of Maintenance**

Regular maintenance is essential to ensure your mower continues to deliver safe and high-quality performance.

To help you properly care for your mower, the following pages include a recommended maintenance schedule, routine inspection procedures, and simple maintenance procedures using basic hand tools. Maintenance is the responsibility of the owner and must be performed regularly. More difficult service tasks or tasks that require special tools are best handled by a recommended service technician or other qualified mechanic.

The maintenance schedule described on page 15 applies to mowers used under normal operating conditions. If you operate your mower under severe conditions, such as sustained prolonged use or high-temperature operations, or use it in unusually wet, dusty or rocky conditions, consult your servicing dealer for recommendations applicable to your individual needs and use.

Be sure to use genuine BEAST mower replacement parts when servicing your mower to assure the best quality, safety and performance for your mower.

**Need Help? Parts, Service and Technical Assistance**  
**Call: 1-919-550-3221 [www.brushbeast.com](http://www.brushbeast.com)**



**CAUTION!** Before making any adjustments and/or servicing to your TURF BEAST mower, make sure the mower is on a flat and level surface, with the ignition switch off, the key removed, and the blades disengaged. Also, disconnect the spark plug wires from the spark plugs and ground them against the engine to prevent inadvertent starting.

If adjustment or maintenance is being performed after operation of the mower, allow the unit to cool since heat build up could cause severe burns.

**Tire Pressure**

Incorrect tire pressure may cause the mower to pull to one side and/or result in uneven cut. Always use caution when filling the tires. NEVER exceed the recommended tire pressure.

**Air Filter**

Refer to the Engine Owner’s Manual for the recommended maintenance.

**Fuel**



**DANGER!** Gasoline is highly flammable and explosive. Do not add fuel while the engine is running or is hot. Keep open flames, sparks, and heat away from the fuel and store fuel in containers specifically designed for that purpose. Add fuel outdoors only and if the fuel is spilled, do not start the engine. Manually push the mower away from the spill and wipe up immediately.

Refer to the Engine Owner’s Manual for the type of fuel to use.

A fuel shut off valve is located on the bottom of the fuel tank. It is recommended that the fuel be shut off when transporting between job sites and when storing the mower for the extended periods of time.

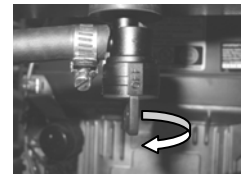

**Engine Oil**

**CHECK ENGINE OIL BEFORE EACH USE.** Refer to the Engine Owner’s Manual for the type of oil to use, oil change intervals, and the proper procedures to check and change oil.

**Blades**



**CAUTION!** Always wear work gloves when performing blade maintenance and beware of the cutting edges. Be sure the engine is off, the key removed, and the spark plug wires are disconnected from the spark plugs to prevent inadvertent starting.

Inspect blades on a daily basis for nicks, bends, and excessive wear. If the blades are worn, cracked, bent, or damaged, replace them before using the mower. Choose genuine BEAST mower replacement blades to ensure quality and performance. (See page 13 for blade removal instructions.)

When sharpening the blades, sharpen only the cutting edges and try to maintain the original angle of the blade. Do not make the cutting edge razor sharp. Remove the same amount from each side of the blade so that balance is maintained.

Item	Procedure	Time Interval				
		Break-in (first 5 hrs)	Every 8 hrs (daily)	Every 40 hrs (weekly)	Every 100 hrs (Bi-weekly)	Every 200 hrs (monthly)
Belts	Inspect (adjust if needed)	X	X			
Blades	Inspect and Sharpen		X			
Engine Air Filter	Inspect (see Engine Owner's Manual)		X			
Engine Cooling Areas	Clean (see Engine Owner's Manual)				X	
Engine Oil	Check (see Engine Owner's Manual)		X			
	Change (see Engine Owner's Manual)	X		X		
Engine Oil Filter	Change (see Engine Owner's Manual)	X				X
Engine Spark Plug	Inspect (see Engine Owner's Manual)					X
Fuel Filter	Replace				X	
Fuel Line	Check				X	
Grease Fittings	Refer to page 20					
Hardware	Check for proper tightness	X		X		
Mower Main Frame	Remove debris from under belt cover		X			
Safety Interlock System	Check Remote Safety Switch		X			
Tires	Check Air Pressure			X		
Spindle/Blade Brakes			X			

**Cleaning the Mower**

It is recommended that the THE BEAST lawn mower be cleaned on a daily basis. Excessive accumulation of dirt, debris, oil, etc. causes premature wear on the components and may present a potential safety hazard.



**DANGER:** Before making any adjustments or servicing your mower, make sure the mower is on level ground, the blades are disengaged, the key is removed, the engine is off and the spark plug wires are disconnected from the spark plugs to prevent inadvertent starting. If maintenance or adjustments are being performed after operation of the mower, allow the unit to cool since heat build up could cause severe burns.

### Engine-to-Blade Belt Adjustment

1. Remove the deck cover and move the blade control lever on the control console to the ON position.
2. With approximately 10 lbs of pressure being applied on the engine to blade belt midway between with pulleys, the belt should move approximately .5 inch.

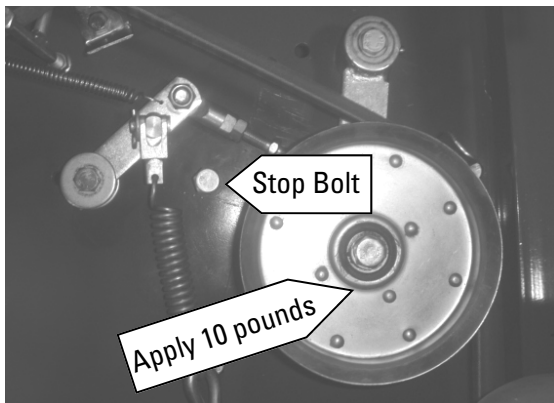

3. If the belt moves more than .5 inch, move the blade control lever back to the OFF position.
4. Loosen locking nut.
5. Rotate turnbuckle until desired tension is achieved.
6. Tighten locking nut when finished.
7. Replace deck cover.

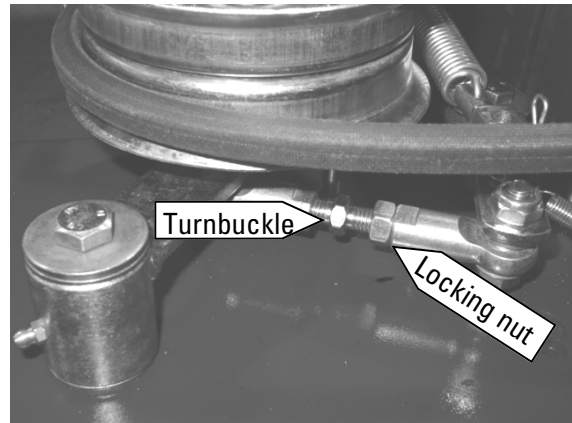

**IMPORTANT!** The mower belts are adjusted to ensure the blades stop turning within seven (7) seconds of releasing the blade control lever. If you are making any belt adjustments whatsoever, for your safety and the safety of others around you, you must ensure the belts are re-adjusted to achieve this design specification. When wing mowers are in use, the blades may not stop in seven (7) seconds. Visual warning disks on both of the wing mowers indicate whether the blades are turning. Do not approach the mower or attempt any service until after the visual warning disks have completely stopped turning.

### Safety System

The most important safety system on a tow behind mower is the operator. THE BEAST is equipped with a remote shut-down switch. The operator is responsible to be aware of the surroundings, focus on safe operation of the mower and be prepared to shut the engine down immediately, if necessary.

Use the remote shut-down switch to stop the blades if:

- There is any unusual noise or excessive vibration coming from THE BEAST. Unexpected noise or vibration are usually a sign of an oncoming problem.
- Any person, child, animal, or personal property is in the mowing area.
- The mower begins to slide down a slope or into a ditch.
- The mower becomes jack-knifed during towing.
- There is a loss of braking power on the towing vehicle.
- The towing vehicle or THE BEAST becomes stuck in mud or any other obstacle.
- If any part of THE BEAST becomes entangled in any type of obstacle.

If there is a situation you are uncertain is safe, DO NOT attempt operating THE BEAST in the area.



ALWAYS inspect the area to be mowed for any stones, sticks, wire, and other foreign objects. These objects may become projectiles that can cause serious injury and/or death when struck by the mower.

To ensure proper lubrication of moving parts, GXi recommends that you lubricate the following components with a high-quality, EP2 high-temperature-based grease or equivalent. Should the conditions of operation be more severe than normal, the lubrication interval may need to be shortened. GTR/OPE grease is the recommended lubricant.

**Lubrication Point Locations**

THE BEAST had fourteen (14) lubrication points.

**Lubricate after every 50 hours of usage**

1. Front wheels (4 locations, 1 on each wheel shaft and 1 on each wheel axle) 
2. Rear wheels (2 locations, 1 each wheel axle) 
3. Spindles (4 locations). **Note:** The lower spindle bearing is sealed on the bottom and open on the top. The upper spindle bearing is sealed on both sides. Failure to frequently replenish grease will cause premature lower bearing failure. Frequent application of grease to this bearing is critical to achieving long spindle life in harsh duty environments. 

4. Wing belt tensioner (2 locations, 1 on each wing) 

5. Blade linkage (1 location) 

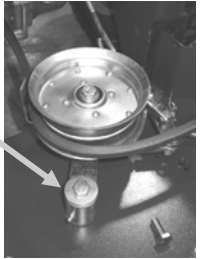
6. Clutch(1 location) 



<b>Problem</b>	<b>Possible Causes</b>	<b>Solution</b>
Engine will not start	<ol style="list-style-type: none"> <li>1. Key in the OFF position</li> <li>2. Insufficient fuel in the tank</li> <li>3. Air bubble in the fuel line</li> <li>4. Fuel valve in OFF position</li> <li>5. Choke not ON</li> <li>6. Choke linkage out of adjustment</li> <li>7. Low engine oil</li> <li>8. Blade control in ON position</li> <li>9. Loose spark plug wire</li> <li>10. Fouled spark plug</li> <li>11. Plugged or dirty air filter</li> <li>12. Bad gasoline</li> <li>13. Plugged or dirty fuel filter</li> <li>14. Safety switches out of alignment or loose</li> <li>15. Dead battery (electric start models)</li> </ol>	<ol style="list-style-type: none"> <li>1. Turn key to ON position</li> <li>2. Add gasoline</li> <li>3. Prime engine or shake bubble out</li> <li>4. Turn valve ON</li> <li>5. Turn choke ON</li> <li>6. Refer to Engine Owner's Manual</li> <li>7. Add engine oil</li> <li>8. Push lever to OFF position</li> <li>9. Tighten wire or connections</li> <li>10. Clean or replace the plug</li> <li>11. Clean or replace the air filter</li> <li>12. Drain and replace the gasoline</li> <li>13. Replace the fuel filter</li> <li>14. Adjust or tighten switches (p. 17) - read warnings!</li> <li>15. Recharge or replace battery</li> </ol> <p><i>To test whether the blade activation safety switches are a contributing factor to the engine not starting, depress the Operator Presence Switch on the handle bars while trying to start the engine. If engine starts, a safety switch adjustment is required.</i></p>
Engine will not keep running/quits	<ol style="list-style-type: none"> <li>1. Water in the fuel</li> <li>2. Loose safety switch</li> <li>3. Fuel valve is OFF</li> <li>4. Dirty fuel filter</li> <li>5. Dirty air filter</li> <li>6. Low engine oil</li> </ol>	<ol style="list-style-type: none"> <li>1. Drain and replace fuel</li> <li>2. Adjust switch (p. 17)</li> <li>3. Turn fuel valve ON</li> <li>4. Replace fuel filter</li> <li>5. Clean or replace air filter</li> <li>6. Add engine oil</li> </ol>
Engine stops when blades are engaged	<ol style="list-style-type: none"> <li>1. Loose safety switch</li> <li>2. Belt tension too high</li> <li>3. Blades jammed with foreign material</li> </ol>	<ol style="list-style-type: none"> <li>1. Adjust switch (p. 17)</li> <li>2. Adjust belt (p. 19)</li> <li>3. Remove foreign material</li> </ol> <p><b>Note:</b> Firmly pushing the blade control lever into the OFF position to ensure the safety switch is fully engaged can sometimes resolve this problem.</p>
Blades do not turn	<ol style="list-style-type: none"> <li>1. Broken belt</li> <li>2. Loose belt</li> <li>3. Blade activation linkage out of adjustment.</li> </ol>	<ol style="list-style-type: none"> <li>1. Replace belt</li> <li>2. Adjust belt (p. 19)</li> <li>3. Adjust linkage (p. 13)</li> </ol>
Belts squeal when blades are engaged	<ol style="list-style-type: none"> <li>1. Incorrect belt tension</li> <li>2. Excessive belt wear</li> </ol>	<ol style="list-style-type: none"> <li>1. Adjust belt tension</li> <li>2. Replace belt</li> </ol>
Belts slip when blades are engaged	<ol style="list-style-type: none"> <li>1. Incorrect belt tension</li> <li>2. Excessive belt wear</li> </ol>	<ol style="list-style-type: none"> <li>1. Adjust belt tension</li> <li>2. Replace belt</li> </ol>

<b>Problem</b>	<b>Possible Causes</b>	<b>Solution</b>
Mower will not move forward or reverse	<ol style="list-style-type: none"> <li>1. Brake ON</li> <li>2. Bypass levers pulled out</li> </ol>	<ol style="list-style-type: none"> <li>1. Release brake on control panel</li> <li>2. Ensure bypass pins are retracted</li> </ol>
Cannot move mower when the engine is off	<ol style="list-style-type: none"> <li>1. Bypass not engaged</li> </ol>	<ol style="list-style-type: none"> <li>1. Pull left and right bypass pins and set them in slots in the chassis (p. 11)</li> </ol>
Engine is overheating	<ol style="list-style-type: none"> <li>1. Dirt in the fuel line</li> <li>2. Dirty air filter</li> <li>3. Low engine oil</li> <li>4. Fouled spark plug</li> <li>5. Misuse of the mower</li> <li>6. Dull blades</li> <li>7. Spindle bearing failure</li> </ol>	<ol style="list-style-type: none"> <li>1. Replace fuel filter and flush tank</li> <li>2. Clean or replace the air filter</li> <li>3. Add engine oil</li> <li>4. Replace spark plug</li> <li>5. Mow slower, wait for grass to dry out</li> <li>6. Sharpen cutting blades</li> <li>7. Take in for service</li> </ol>
Grass not cut smoothly or cleanly	<ol style="list-style-type: none"> <li>1. Dull blades</li> <li>2. Mowing too fast for conditions</li> <li>3. Grass is wet or bent over</li> <li>4. Blade is bent</li> <li>5. Tire pressure not equal</li> <li>6. Deck is set at uneven heights</li> <li>7. Blades are set upside down</li> <li>8. Excessive grass and debris build up underneath the deck</li> </ol>	<ol style="list-style-type: none"> <li>1. Sharpen blades</li> <li>2. Slow down while cutting</li> <li>3. Let grass dry to stand up</li> <li>4. Replace blade</li> <li>5. Add air pressure to low tires</li> <li>6. Set deck at equal heights</li> <li>7. Take blades off and install correctly</li> <li>8. Clean out debris</li> </ol>
Mower always pulls to one side	<ol style="list-style-type: none"> <li>1. Controls out of adjustment</li> <li>2. Transmission failure</li> </ol>	<ol style="list-style-type: none"> <li>1. Adjust controls (p. 11)</li> <li>2. Take in for service</li> </ol>

Products Covered by this Warranty	Length of Warranty: *(from the date of original retail purchase)		
	Residential	Commercial	Rental
Engine	Manufacturer's warranty	Manufacturer's warranty	Manufacturer's warranty
Transmission	Manufacturer's warranty	Manufacturer's warranty	Manufacturer's warranty
Mower frame	Lifetime (original owner only)	Lifetime (original owner only)	90 days
Belts, Tires, Battery	90 days	90 days	90 days
Attachments	1 yr limited	1 yr limited	30 day limited

\*LENGTH OF WARRANTY: Batteries supplied with applicable products as standard, original equipment are covered by this warranty for a period of 90 days from the date of original retail product purchase. Consumable parts such as oil, spark plugs, filters, and blades are not covered by this warranty.

**To Qualify for this Warranty**

The product must be purchased in the United States from a dealer authorized by GXi Outdoor Power, LLC to sell those products. This warranty applies to first retail purchaser/owner during the applicable warranty time period. **NO WARRANTY REGISTRATION IS NECESSARY TO OBTAIN WARRANTY ON BEAST PRODUCTS. SAVE YOUR PROOF OF PURCHASE RECEIPT. MUST HAVE PROOF OF PURCHASE TO OBTAIN WARRANTY.**

**What GXi Outdoor Power Will Repair or Replace under Warranty**

GXi will repair or replace, at its option, any part that is proven to be **defective in material or workmanship** under normal use during the applicable warranty time period subject to the exclusions stated herein. This warranty is void if the owner fails to follow the prescribed maintenance and operating procedures described in this manual. This specifically refers to ensuring routine lubrications and oil changes are made, that fuel stabilizer is used when the product is stored and that the product is not overloaded.

GXi has the right to recover warranty administration costs from the owner if the root cause of the malfunction is found to be other than defective material or workmanship. In particular, this warranty does not cover: contaminants in the fuel or oil; damage caused by not following the prescribed warnings and operating practices; failure to follow proper maintenance and storage procedures; and physical damage due to misuse, shipping, handling or storage.

Warranty repairs will be made without charge for parts and labor for the first year.

Anything replaced under warranty becomes the property of GXi. Parts replaced under warranty will be considered as part of the original product and any warranty on those parts will expire coincident with the original product warranty.

**To Obtain Warranty Service**

You must take the BEAST product, accessory, replacement part, apparel or the power equipment on which the accessory or replacement part is installed, and proof of purchase, at your expense, to any BEAST service location in the United States, who is authorized to service that product, during the service location's normal business hours. If you are unable to obtain warranty service, or are dissatisfied with the warranty service you receive, take the following steps: First, contact the manager of the service center involved; normally this will resolve the problem. However, if you should require further assistance, write or call the GXi Parts & Service, LLC 1-919-550-3221

**Exclusions**

This warranty does not cover: normal wear, contaminants in the fuel or oil; damage as a result of use in an application for which the product was not designed; damage caused by incorporation or use of unsuitable attachments or parts, unauthorized alteration, or other misuse and neglect; damage caused by failure to follow the prescribed warnings, operating practices, proper maintenance and storage procedures; parts affected or damaged by accident and/or collision; damage due to shipping, handling, storage or any causes other than defects in material or workmanship of the product.

**Disclaimer of Consequential Damage and Limitation of Implied Warranties**

GXi disclaims any responsibility for loss of time or use of the product, transportation, commercial loss, or any other incidental or consequential damage. Any implied warranties are limited to the duration of this written limited warranty.

**THIS WARRANTY IS VOID IF THE MANUFACTURING DATE AND THE SERIAL NUMBER ON THE EQUIPMENT HAS BEEN REMOVED OR THE EQUIPMENT HAS BEEN MODIFIED.**